

Desk Docking for M700D

DD-M70D

Product Features:

- Compatible with Winmate M700D Tablet PC
- Hold the tablet on the desk and support multiple I/O
- Supported I/O: 1 x COM, 1 x LAN, 2 x USB, DC-in (2.5Ø power jack input)
- Side I/O supported : 2 x USB

Mechanical Drawing

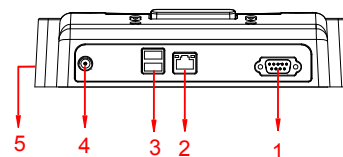
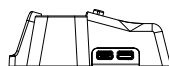
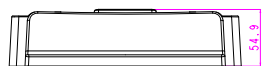
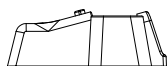
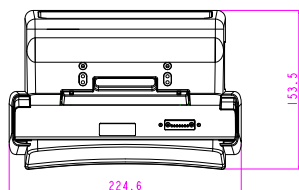

Front View

Side View

IO View

1. 1 x COM (RS232) with 12V 1A
2. 1 x LAN (10/100)
3. 2 x USB
4. DC-IN (2.5Ø)
5. 2 x USB

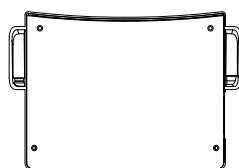

Installation Procedure

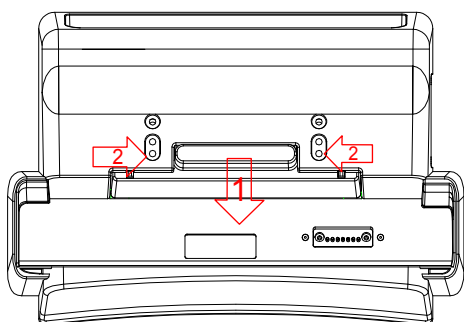

Top View

1. Pull down the latch
2. Insert the screw and tighten it
3. Insert the M700DM4 into the table docking, align the Pogo pin and make sure it is attached properly



Rear View

Specification

Dimension	224.6 x 153.5 x 54.9 mm
Power Input	12V DC-in
I/O support	1 x COM, 1 x LAN, 2 x USB, 1 x DC-in
Side I/O	2 x USB 2.0

Rev.	Reasons	Revised Date
1.0	First Release	May-16-2014