

# M700DM8

## Rugged Android Tablet

ARM® Cortex™-A53 Octa-Core, 1.3 GHz

Android 7.0 Nougat

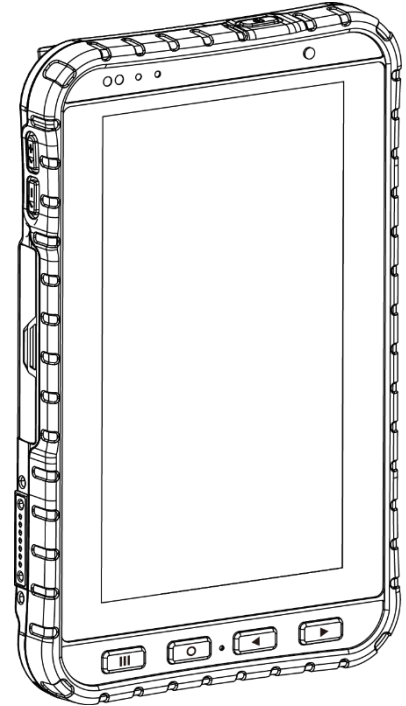

# User Guide

---

# Contents

|  |           |
|--|-----------|
| <b>PREFACE</b> .....   | <b>4</b>  |
| ADVISORY CONVENTIONS .....                                   | - 4 -     |
| SAFETY INFORMATION .....                                     | 5         |
| HANDLING AND MAINTENANCE .....                               | 7         |
| DECLARATION OF CONFORMITY (DOC).....                         | 8         |
| ABOUT THIS USER GUIDE .....                                  | 9         |
| <b>CHAPTER 1: GETTING STARTED</b> .....                      | <b>10</b> |
| 1.1 INTRODUCTION .....                                       | 11        |
| 1.2 PRODUCT FEATURES.....                                    | 11        |
| 1.3 UNPACKING.....   | 11        |
| 1.4 DESCRIPTION OF PARTS .....                               | 12        |
| 1.5 DIMENSIONS .....   | 15        |
| 1.6 GETTING STARTED .....                                    | 15        |
| 1.6.1 SIM Card and SD Card Installation .....                | 16        |
| 1.6.2 Battery Installation .....                             | 17        |
| 1.6.3 Hot Swapping Batteries.....                            | 18        |
| 1.6.4 Charging the Battery .....                             | 18        |
| 1.7 TURNING ON AND OFF THE DEVICE .....                      | 19        |
| 1.7.1 Turning On.....  | 19        |
| 1.7.2 Turning Off.....                                       | 19        |
| 1.8 RESETTING TO FACTORY DEFAULTS.....                       | 20        |
| <b>CHAPTER 2: USING THE TABLET</b> .....                     | <b>21</b> |
| 2.1 USING THE TOUCH SCREEN .....                             | 22        |
| 2.2 WAKING UP THE TABLET.....                                | 23        |
| 2.3 USING THE HOME SCREEN.....                               | 23        |
| 2.3.1 Personalizing Home Screen.....                         | 24        |
| 2.3.2 Viewing other parts of the Home Screen .....           | 26        |
| 2.4 STATUS AND NOTIFICATION ICONS .....                      | 27        |
| 2.4.1 Notification Icons .....                               | 27        |
| 2.4.2 Status Icons.....                                      | 27        |
| 2.5 USING THE ON-SCREEN KEYBOARD .....                       | 28        |
| 2.5.1 Entering Text .....                                    | 28        |
| 2.5.2 Editing Text.....                                      | 29        |
| 2.6 DISPLAY SETTINGS.....                                    | 30        |
| 2.7 AUDIO PROFILE SETTINGS .....                             | 32        |
| 2.7.1 Sound Settings .....                                   | 32        |
| 2.7.2 Adjusting Volume.....                                  | 32        |
| 2.8 LANGUAGE AND KEYBOARD SETTINGS.....                      | 33        |
| 2.8.1 Changing the Keyboard Language.....                    | 34        |
| 2.9 ABOUT PHONE .....  | 34        |
| <b>CHAPTER 3: WINMATE HOME MANAGER</b> .....                 | <b>36</b> |
| 3.1 HOW TO LOCK APPLICATIONS .....                           | 37        |
| 3.2 HOW TO UNLOCK APPLICATIONS .....                         | 39        |
| 3.3 HOW TO CHANGE PASSWORD .....                             | 41        |
| <b>CHAPTER 4: NETWORKS AND WIRELESS DEVICES</b> .....        | <b>42</b> |
| 4.1 CONNECTING TO MOBILE NETWORKS .....                      | 43        |
| 4.1.1 Checking the Network (GPRS/3G/4G) Connection.....      | 43        |
| 4.1.2 Turning on Data Service.....                           | 43        |
| 4.2 CONNECTING TO WI-FI NETWORKS .....                       | 44        |
| 4.2.1 Turning on Wi-Fi and Connecting to Wi-Fi Networks..... | 44        |

|   |           |
|---|-----------|
| 4.2.2 Adding Wi-Fi Network.....                               | 45        |
| 4.3 CONNECTING TO BLUETOOTH DEVICES .....                     | 46        |
| 4.3.1 Turning Bluetooth On or Off .....                       | 46        |
| 4.3.2 Connecting to Bluetooth Device .....                    | 46        |
| 4.3.3 Disconnecting Bluetooth Device.....                     | 46        |
| 4.4 CONNECTING TO COMPUTER VIA USB.....                       | 47        |
| 4.4.1 USB Computer Connection .....                           | 47        |
| 4.4.2 USB Debugging Settings.....                             | 48        |
| <b>CHAPTER 5: USING CAMERA .....</b>                          | <b>49</b> |
| 5.1 CAPTURING PHOTOS OR VIDEO.....                            | 50        |
| 5.1.1 Opening Camera .....                                    | 50        |
| 5.1.2 Taking pictures .....                                   | 50        |
| 5.1.3 Viewing pictures .....                                  | 50        |
| 5.1.4 Shooting videos.....                                    | 51        |
| 5.2 THE GALLERY .....   | 51        |
| <b>CHAPTER 6: USING BARCODE READER .....</b>                  | <b>52</b> |
| 6.1 USING BARCODE READER.....                                 | 53        |
| 6.1.1 Barcode Reader Location.....                            | 53        |
| 6.1.2 Android Winmate® Data Collection (WDC).....             | 53        |
| 6.1.3 Where to Find WDC .....                                 | 53        |
| 6.1.4 How to Turn On/Off the Power of Barcode Reader.....     | 54        |
| 6.1.5 How to Change the Symbologies of Barcode .....          | 55        |
| 6.1.6 How to Add Command to the Barcode Output.....           | 55        |
| 6.1.7 How to Change the Scan Type of the Barcode Reader ..... | 56        |
| 6.1.8 How to Change WDC Settings or Reset to Default.....     | 56        |
| 6.1.9 Scanning a Barcode .....                                | 57        |
| 6.1.10 Scanning Tips and Considerations.....                  | 57        |
| <b>CHAPTER 7: ACCESSORIES .....</b>                           | <b>58</b> |
| 7.1 STANDARD ACCESSORIES.....                                 | 59        |
| 7.2 OPTIONAL ACCESSORIES.....                                 | 59        |
| <b>APPENDIX.....</b>  | <b>60</b> |
| <b>APPENDIX A: PRODUCT SPECIFICATIONS.....</b>                | <b>61</b> |
| <b>APPENDIX B: ORDER INFORMATION .....</b>                    | <b>62</b> |
| <b>APPENDIX C: SOFTWARE DEVELOPMENT KIT .....</b>             | <b>62</b> |
| <b>APPENDIX D: OS IMAGE UPDATE .....</b>                      | <b>62</b> |
| <b>APPENDIX E: OTA ONLINE UPDATE .....</b>                    | <b>63</b> |

## Preface

### Advisory Conventions

Four types of advisories are used throughout the user manual to provide helpful information or to alert you to the potential for hardware damage or personal injury. These are Notes, Important, Cautions, and Warnings. The following is an example of each type of advisory.

**Note:**

A note is used to emphasize helpful information

**Important:**

An important note indicates information that is important for you to know.

**Caution/ Attention**

A Caution alert indicates potential damage to hardware and explains how to avoid the potential problem.

Une alerte d'attention indique un dommage possible à l'équipement et explique comment éviter le problème potentiel.

**Warning! Avertissement!**

An Electrical Shock Warning indicates the potential harm from electrical hazards and how to avoid the potential problem.

Un Avertissement de Choc Électrique indique le potentiel de choc sur des emplacements électriques et comment éviter ces problèmes.

## Safety Information



### Precaution on Battery Pack *Précaution avec le bloc-pile*

Do Not Disassemble, Modify, or Insert Sharp Objects Into the Battery Pack. Electrolyte leakage, generation of heat, ignition or rupture may result.

*[FR] Ne pas démonter, modifier, ou insérer des objets pointus à l'intérieur du bloc-pile. Une fuite d'électrolyte, la génération de chaleur, l'amorçage ou la rupture peuvent être occasionnés.*

Do Not Short the Positive (+) and Negative (-) Terminals of the Battery. Generation of heat, ignition or rupture may result. When carrying or storing the device, do not place the battery pack together with articles that may contact electricity.

*[FR] Ne pas court-circuiter les bornes Positive (+) et Négative (-) de la pile, la génération de chaleur, l'amorçage ou la rupture peuvent être occasionnés. Lors du transport et du rangement de l'appareil, ne pas placer le bloc-pile en même temps que des articles pouvant créer un contact électrique.*

Do Not Apply Shocks to the Battery by Dropping It or Applying Strong Pressure to It. Electrolyte leakage, generation of heat, ignition or rupture of battery may occurs.

*[FR] Ne pas faire subir de choc à la pile en la laissant tomber ou en appliquant une forte pression dessus. Une fuite d'électrolyte, la génération de chaleur, l'amorçage ou la rupture peuvent être occasionnés.*

Do Not Charge the Battery Other Than Methods Those Specified In This Manual. If the battery is not charged using one of the specified methods, electrolyte leakage, generation of heat, ignition or rupture may result.

*[FR] Ne pas charger la pile par d'autres méthodes que celles spécifiées dans ce manuel. Si la pile n'est pas chargée en utilisant l'une des méthodes spécifiées, une fuite d'électrolyte, la génération de chaleur, l'amorçage ou la rupture peuvent être occasionnés.*

When the Battery Pack Has Deteriorated, Replace It with a New Battery. Continued use of a damaged battery pack may result in heat generation, ignition or battery rupture.

*[FR] Lorsque la pile est détériorée, la remplacer par une nouvelle pile. L'utilisation continue d'une pile endommagée peut occasionner une génération de chaleur, l'amorçage ou la rupture de la pile.*

Do Not Expose the Battery Pack to Excessive Heat, or Extreme Heat (Near Fire, in Direct Sunlight for example) Generation of heat, ignition or rupture may result

*[FR] Ne pas exposer le bloc-pile à une Chaleur Excessive, ou une Chaleur Extrême (Près d'un feu, sous la lumière du soleil par exemple) Une production de chaleur, l'amorçage ou la rupture peuvent être occasionnés*

Do Not Use the Battery Pack With Any Other Products. The battery pack is rechargeable and is only designed for this specific product. If it is used with a product other than the specified product, electrolyte leakage, generation of heat, ignition or rupture may result.

*[FR] Ne pas utiliser avec un autre produit La batterie est rechargeable et a été conçue pour un produit spécifique. Si elle est utilisée sur un produit différent de celui pour lequel elle a été conçue, des pertes d'électrolytes et une production de chaleur sont possibles, elle risque également de prendre feu ou de casser.*

Do Not Use This Product With Battery Other Than the One Specified.

*[FR] Ne pas utiliser ce produit avec une batterie autre que celle spécifiée*

Discontinue using device immediately if you notice the battery is swelling, or looks puffy or misshapen. Do not attempt to charge or use the device. Do not handle a damaged or leaking battery. Do not let leaking battery fluid come into contact with your eyes, skin or clothing.

*[FR] Si vous remarquez une pile gonflée, élargie ou anormale, cesser l'utilisation de l'appareil immédiatement. N'essayez pas de recharger l'appareil ou de l'utiliser. Ne pas manipuler une pile qui fuit ou qui est endommagée. Ne laissez pas de liquide qui fuit entrer en contact avec vos yeux, votre peau ou vos vêtements.*



**General Product Safety**  
**Sécurité générale des produits**

- Do not block any ventilation openings. Do not place the product against a wall or in an enclosed space as doing so might impede the flow of cooling air.
- *[FR] Ne pas bloquer les ouvertures de ventilation. Ne pas placer le produit contre un mur ou dans un espace clos de façon à entraver la circulation de l'air de refroidissement.*

- Do not place the product near any heat sources such as radiators, warm air intakes, stoves or other heat-generating devices (including amplifiers or other heat producing equipment).
- *[FR] Ne pas placer le produit près d'une source de chaleur comme des radiateurs, les arrivées d'air chaud, poêles ou autres produits générant de la chaleur (y compris les amplificateurs ou autre équipement produisant de la chaleur.)*

- Protect the power cord from being crushed or pinched, particularly in the area of the plugs, any receptacles used, and the point of exit from the apparatus. Do not break off the ground pin of the power cord.
- *[FR] Empêcher le cordon d'alimentation d'être écrasé ou pincé, en particulier dans les zones de prises, des containers utilisés, et du point de sortie de l'appareil. Ne pas casser la broche de terre du cordon d'alimentation.*

- Do not disregard the safety that a polarized or grounded connection can provide. A polarized connection consists of two plugs, one of which is larger than the other. A grounded connection has two blades and a third one that is grounded. If the main plug provided cannot be inserted into your outlet, consult an electrician to replace your obsolete outlet.
- *[FR] Ne pas ignorer la sécurité qu'une prise polarisée ou une prise de terre peut prévoir. Une prise polarisée se compose de deux fiches, dont l'une est plus large que l'autre. Une prise de terre possède deux lames et une troisième qui est la terre. Si la fiche principale fournie ne peut être insérée dans votre prise, consultez un électricien pour remplacer votre prise obsolète.*

- Use only accessories specified by the manufacturer.  
*[FR] Utiliser uniquement les accessoires spécifiés par le fabricant.*

- This product should not be used near water such as bathtubs, sinks, swimming pools, wet basement, etc.  
*[FR] Ce produit ne doit pas être utilisé près de l'eau comme les baignoires, les éviers, les piscines, les sous-sols humides, etc.*

- Use only with its transport carriage, stand, tripod, console or table specified by the manufacturer or sold with the product. When using a carriage, move the carriage assembly with the product carefully to avoid damage from falling over.
- *[FR] Utiliser uniquement avec son chariot de transport, support, trépied, console ou table spécifiés par le fabricant ou vendu avec le produit. Lors de l'utilisation d'un charriot, déplacez l'ensemble charriot avec le produit avec soin pour éviter tout dommage de chute.*

- Unplug this apparatus during lightning storms or when it is not being used for long periods.
- *[FR] Débrancher cet appareil durant les orages ou lorsqu'il n'est pas utilisé pendant de longues périodes.*

- Refer all servicing to qualified service personnel. A technical intervention is required when the apparatus has been damaged in any way, for example if the power cord or plug is damaged, liquid has been spilled or objects have fallen inside the unit, if the product has been exposed to rain or moisture, if it does not operate normally or if it has been dropped.
- *[FR] Confier toute réparation à du personnel qualifié. Une intervention technique est nécessaire lorsque l'appareil a été endommagé de quelque façon, par exemple si le cordon d'alimentation ou la fiche est endommagé, du liquide a été renversé ou des objets sont tombés à l'intérieur de l'unité, si le produit a été exposé à la pluie ou à l'humidité, s'il ne fonctionne pas normalement ou s'il a été jeté.*

## Handling and Maintenance



### General Guideline Guide Général

Keep the product at least 13 cm (5 inches) away from electrical appliances that can generate a strong magnetic field such as TV, refrigerator, motor, or a large audio speaker.  
 [FR] Garder le produit au moins à 13 cm (5 pouces) de distance des appareils électriques qui peuvent générer un fort champ magnétique comme une télévision, un réfrigérateur, un moteur, ou un important haut-parleur.

Do not place heavy objects on top of the tablet computer as this may damage the display.  
 [FR] Ne pas placer d'objets lourds sur le dessus de l'ordinateur tablette cela peut endommager l'écran.

The screen surface can be easily scratched. Use with care. Do not use paper towels to clean the display but use the included cleaning cloth. Avoid touching it with a pen or pencil.  
 [FR] La surface de l'écran peut être facilement rayée. Utiliser avec précaution. Ne pas utiliser de serviette en papier pour nettoyer l'écran mais utiliser le chiffon de nettoyage inclus. Éviter de toucher avec un stylo ou un crayon.

To maximize the life of the backlight in the display, allow backlight to automatically turn off as a result of power management. Avoid using a screen saver or other software that prevents the power management from working.  
 [FR] Pour maximiser la durée de vie du rétroéclairage de l'écran, autoriser le rétroéclairage résultant de la gestion de l'alimentation. Éviter d'utiliser un économiseur d'écran ou un autre logiciel empêchant la gestion de l'alimentation de fonctionner.



### Cleaning Guideline Guide de nettoyage

Use a soft cloth moistened with water or a non-alkaline detergent to wipe the exterior of the product.  
 [FR] Utiliser un chiffon doux humidifié avec de l'eau ou un détergeant non alcalin pour essuyer l'extérieur du produit.

Gently wipe the display with a soft, lint-free cloth. Do not use alcohol or detergent on the product.

[FR] Essuyer délicatement l'écran avec un chiffon doux non pelucheux. Ne pas utiliser d'alcool ou un détergent sur le produit.



### Touchscreen Guideline Guide de l'écran tactile

Use your finger or the stylus on the display. Using sharp or metallic object may cause scratches and damage the display, thereby causing errors.

[FR] Utiliser votre doigt ou le stylet sur l'écran. L'utilisation d'un objet pointu ou métallique peut provoquer des rayures.

Use a soft cloth to remove dirt on the display. The touchscreen surface has a special protective coating that prevents dirt from sticking to it. Not using a soft cloth may cause damage to the special protective coating on the touchscreen surface. To clean off hard to remove dirt, blow some steam on the particular area and gently wipe away using a soft cloth.  
 [FR] Utiliser un chiffon doux pour enlever la poussière sur l'écran. La surface de l'écran tactile a un revêtement protecteur spécial empêchant la saleté de se coller à lui. Ne pas utiliser un chiffon doux peut endommager le revêtement spécial sur la surface de l'écran tactile. Pour nettoyer les saletés plus difficiles à enlever, souffler de la buée sur la zone particulière et essuyer doucement avec un chiffon doux.

Do not use excessive force on the display. Avoid placing objects on top of the display as this may cause the glass to break.  
 [FR] Ne pas utiliser une force excessive sur l'écran. Éviter de placer des objets au dessus de l'écran cela pourrait provoquer une cassure du verre.

When there is a noticeable discrepancy in the operation of the touchscreen function (your touch does not correlate to the proper location on the screen), recalibrate the touchscreen display.  
 [FR] Lorsqu'il y a un écart sensible dans le fonctionnement de l'écran tactile (votre contact ne correspond pas à la bonne position sur l'écran), recalibrer l'écran tactile.

## Declaration of Conformity (DoC)

### FCC Statement

This device complies with part 15 FCC rules.



Operation is subject to the following two conditions:

- This device may not cause harmful interference.
- This device must accept any interference received including interference that may cause undesired operation

This equipment has been tested and found to comply with the limits for a class "B" digital device, pursuant to part 15 of the FCC rules. These limits are designed to provide reasonable protection against harmful interference when the equipment is operated in a commercial environment. This equipment generates, uses, and can radiate radio frequency energy and, if not installed and used in accordance with the instruction manual, may cause harmful interference to radio communications. Operation of this equipment in a residential area is likely to cause harmful interference in which case the user will be required to correct the interference at his own expense.

### CE Notice (European Union)



Electromagnetic Compatibility Directive (2014/30/EU)

- EN55024: 2010/ A1: 2015
  - IEC61000-4-2: 2009
  - IEC61000-4-3: 2006+A1: 2007+A2: 2010
  - IEC61000-4-4: 2012
  - IEC61000-4-5: 2014
  - IEC61000-4-6: 2014
  - IEC61000-4-8: 2010
  - IEC61000-4-11: 2004
- EN55032: 2012/AC:2013
- EN61000-3-2:2014
- EN61000-3-3:2013

Low Voltage Directive (2014/35/EU)

- EN 60950-1:2006/A11:2009/A1:2010/A12:2011/ A2:2013

This equipment is in conformity with the requirement of the following EU legislations and harmonized standards. Product also complies with the Council directions.



## About This User Guide

This User Guide provides information about using the Winmate® M700DM8 and accessories.



**Note:**

Some pictures in this guide are samples and can differ from actual product.

## Documentation Set

The documentation set for the M700DM8 provides information for specific user needs, and includes:

- **M700DM8 Series Quick Start Guide** - describes how to get the M700DM8 up and running.
- **M700DM8 Series User Guide** – contains detailed description on how to use the M700DM8, its components and features.

## Configurations

This guide covers the following configurations of M700DM8 Series:

| Model Number  | Specifications                         |
|---------------|--|
| M700DM8-4E    | Standard                               |
| M700DM8-4EH   | Standard with hotswap battery          |
| M700DM8-4EBM  | 2D Barcode Reader                      |
| M700DM8-4EBMH | 2D Barcode Reader with hotswap battery |

## Chapter Descriptions

[Chapter 1, Getting Started](#) provides basic instructions on how to use M700DM8, including main SIM card, SD card and battery installation, powering on and resetting M700DM8.

[Chapter 2, Using the M700DM8](#) provides basic instructions on using the M700DM8.

[Chapter 3, Using Winmate Home Manager](#) explains how to use WHM to lock the launcher.

[Chapter 4, Connecting to Network and Devices](#) explains how to connect M700DM8 to networks, Bluetooth devices, and computer.

[Chapter 5, Using Camera](#) provides instructions on how to use camera on M700DM8.

[Chapter 6, Capturing Data](#) provides information on how to use Barcode Reader that might be present in M700DM8.

[Chapter 7, Accessories](#) describes the available accessories and how to use them with the M700DM8.

## **Chapter 1: Getting Started**

This chapter tells you information about Winmate® M700DM8 Series tablet, its highlighted features, and provides basic instructions for using the M700DM8, including powering on and resetting the M700DM8.

---

## 1.1 Introduction

Thank you for purchasing Winmate® M700DM8 Series Industrial tablet. Winmate® M700DM8 Series Industrial tablet is an enterprise-class tablet with powerful mobile computing solution. The M700DM8 tablet brings a new level of flexibility, functionality and rugged design to pocket-sized mobile devices, providing task workers and managers with the power to streamline business processes, increasing productivity and improving customer service.

The M700DM8 packs WLAN, Bluetooth, GPS, and WWAN function - all into a single device. With great multiple wireless communicate design, this product will be applicable to mobile worker, business application, and IT requirements.

## 1.2 Product Features



Winate® M700DM8 Industrial Tablet features:

- ARM® Cortex™-A53 Octa-Core, 1.3 GHz
- 7" (1280 x 720) TFT LCD Display
- Projected Capacitive Multi-Touch Screen
- IP65 and 4ft drop MIL standard
- Built-in G-sensor and Light sensor
- WLAN 802.11 a/b/g/n, Bluetooth 4.0, GPS / AGPS / GLONASS, 3G / 4G LTE
- 8.0MP Rear Camera (with LED auxiliary light, Auto Focus)
- Android™ 7.0 Nougat Operating System
- Optional 2D Barcode Reader

## 1.3 Unpacking

If any of the following items are missing or damaged, contact us.

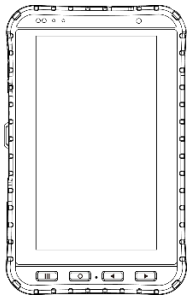
**Standard packing list includes:**

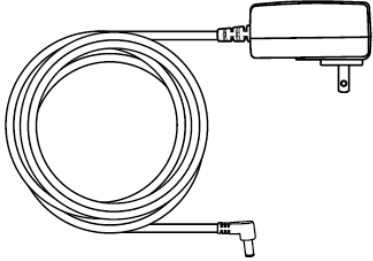
|   |   |   |
|---|---|---|
|  |  |  |
| <p><b>M700DM8</b></p>   | <p><b>Quick Start Guide<br/>(Hardcopy)</b></p>                                      | <p><b>*AC Adapter</b><br/>Input: AC 100-240V 50/60 Hz<br/>Output : 5V-2A</p>          |

\* Adapter socket varies by country and region. M700DM8 will be shipped with the socket according to your order.

Your package may include optional accessories based on your order. To see the list of available accessories and its specifications, refer to [Chapter 7](#) of this User Guide.

## 1.4 Description of Parts

### Front and Side View

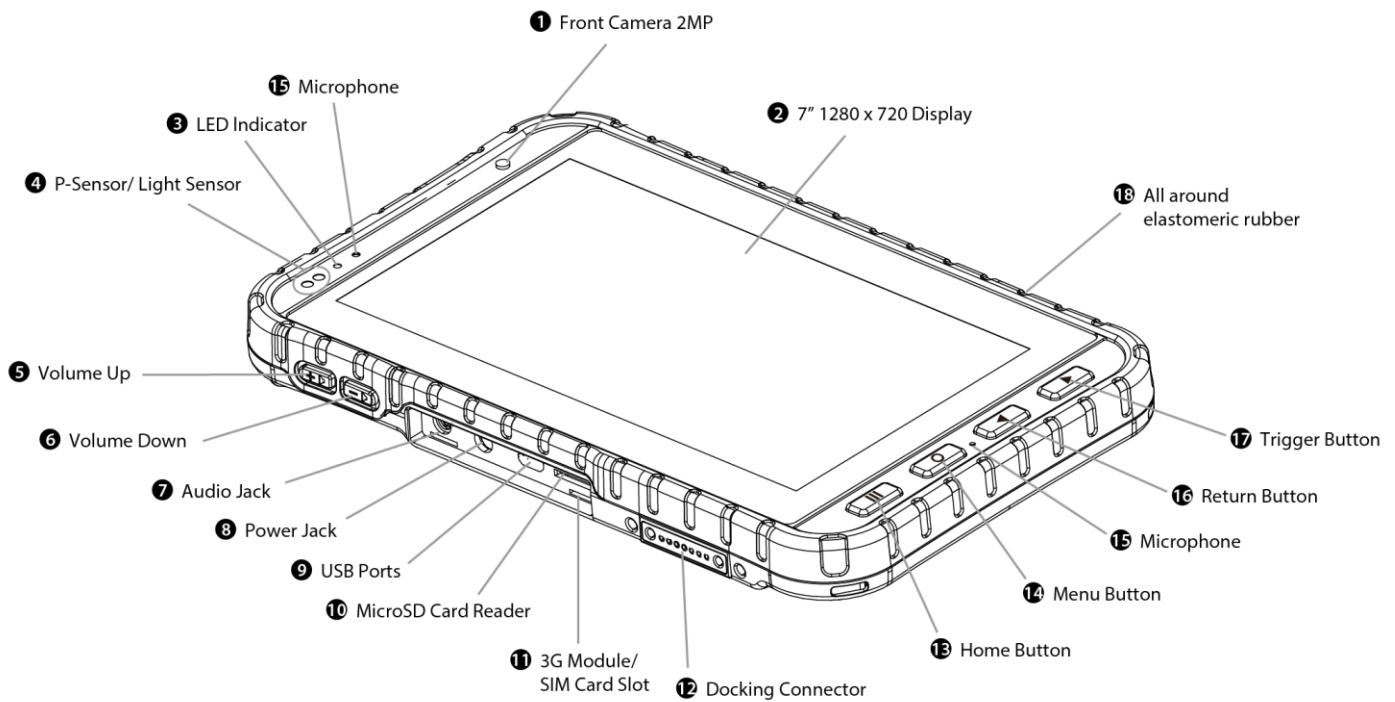

### Description of Parts:

| No | Item                    | Description  |
|----|-------------------------|--|
| 1  | Front Camera            | 2MP Front Camera.  |
| 2  | 7" 1280 x 720 Display   | Displays and act as one of the inputs for the tablet Computer.   |
| 3  | LED Indicator           | Displays status depending on LED color: <ul style="list-style-type: none"> <li>• <b>Green:</b> Indicates the device has finished charging and has 100% Battery</li> <li>• <b>Blue:</b> The LED will display as blue when the device is being turned on.</li> <li>• <b>Red:</b> The device is charging</li> <li>• <b>Continuously Flashing Red:</b> Indicates low battery status (below 15%)</li> <li>• <b>Flashes Red twice:</b> Not enough power for the device to turn on</li> </ul> |
| 4  | P-Sensor / Light Sensor | Proximity Sensor: Turns off the Screen when detecting an object within a specific range.<br>Light Sensor: Display brightness auto-adjusting  |
| 5  | Volume Up               | Increase the volume of music or radio.   |
| 6  | Volume Down             | Decrease the volume of music or radio.   |
| 7  | Audio Jack              | To connect a set of headphones, external speakers, or an audio device.   |
| 8  | Power Jack              | DC-IN power input jack.  |

|    |                                   |  |
|----|-----------------------------------|--|
| 9  | USB Ports                         | To connect USB flash drive 2.0 / mouse / printer / keyboard, etc.                          |
| 10 | MicroSD Card Reader               | Memory card reader port for MicroSD Card.  |
| 11 | 3G Module/SIM Card Slot           | Service window to insert Micro SIM card. Also provide access to 3G Module.                 |
| 12 | Docking Connector                 | Port to docking solutions such as vehicle docking to provide power and external antenna.   |
| 13 | Home Button                       | Return to home screen.   |
| 14 | Menu Button                       | Open a list of actions that user can do on the current screen.                             |
| 15 | Dual Noise Cancelling Microphones | Use for making a phone call or voice recordings.   |
| 16 | Return Button                     | Return to the previous screen.   |
| 17 | Trigger Button                    | If the device was equipped with scanners, this button can be function as a trigger button. |
| 18 | All Around Elastomeric Rubber     | Protects the device from water and dust.   |

## Rear and Top View

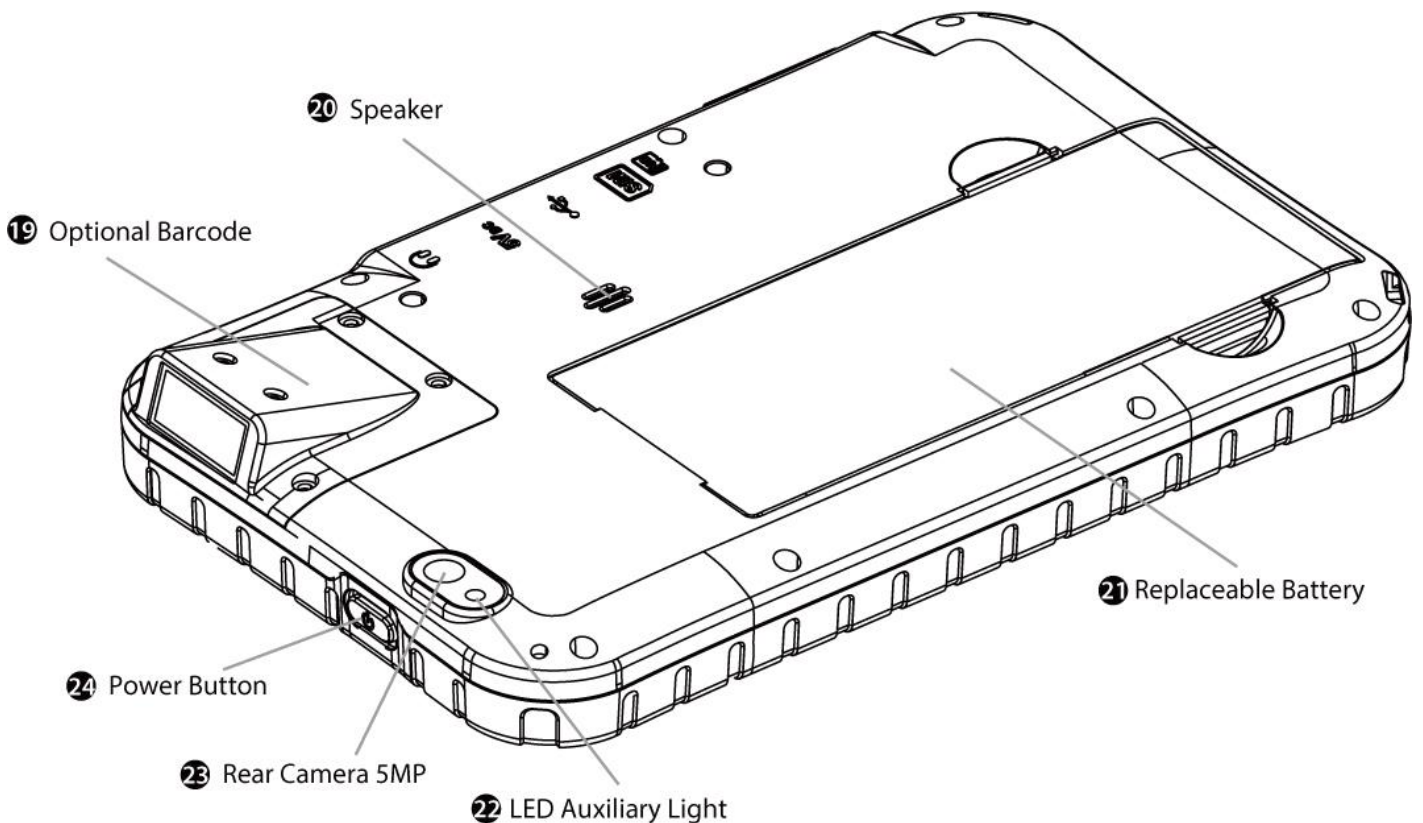

**Description of Parts:**

| No | Item                | Description  |
|----|---------------------|--|
| 19 | Optional Barcode    | Barcode Scanner for reading of 2D barcode.   |
| 20 | Speaker             | Provide audio output for music and video.  |
| 21 | Battery             | Replaceable batter<br>3.7V 5300mAh battery   |
| 22 | LED Auxiliary Light | To provide lighting while using camera   |
| 23 | Rear Camera         | 5MP Autofocus Camera. Captures photos and videos.  |
| 24 | Power Button        | <p>Press and hold the button for 3 seconds to turn on M700DM8</p> <p>Press to turn on/off the screen</p> <p>Press and hold the button for 3 seconds to select:</p> <ul style="list-style-type: none"> <li>• <b>Power Off</b> -- to turn off the M700DM8<br/>press button for 8 Sec to force system power off</li> <li>• <b>Airplane Mode</b> – to disable all wireless connection</li> <li>• <b>Restart</b> – to restart the device</li> </ul> |

## 1.5 Dimensions

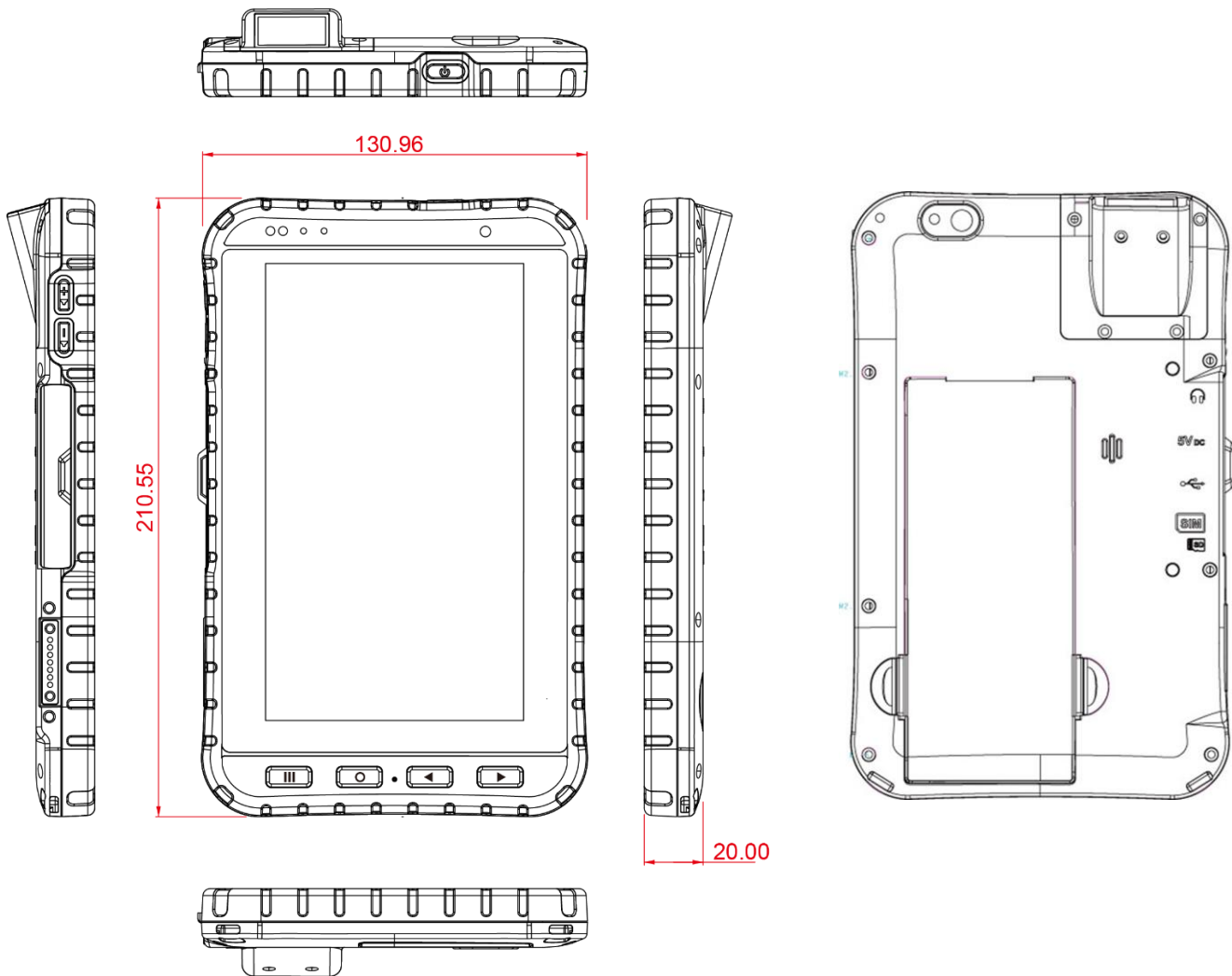

*\*Note: this is a simplified drawing and some components are not marked in detail.*

## 1.6 Getting Started

To start using the M700D8 for the first time:

- Install SIM Card
- Install Micro SD Card
- Install the Battery
- Charge the M700DM8
- Power on the M700DM8
- Configure the M700DM8

## 1.6.1 SIM Card and SD Card Installation

To Install the SIM Card and SD Card:

1. Open the I/O cover located on the left side.

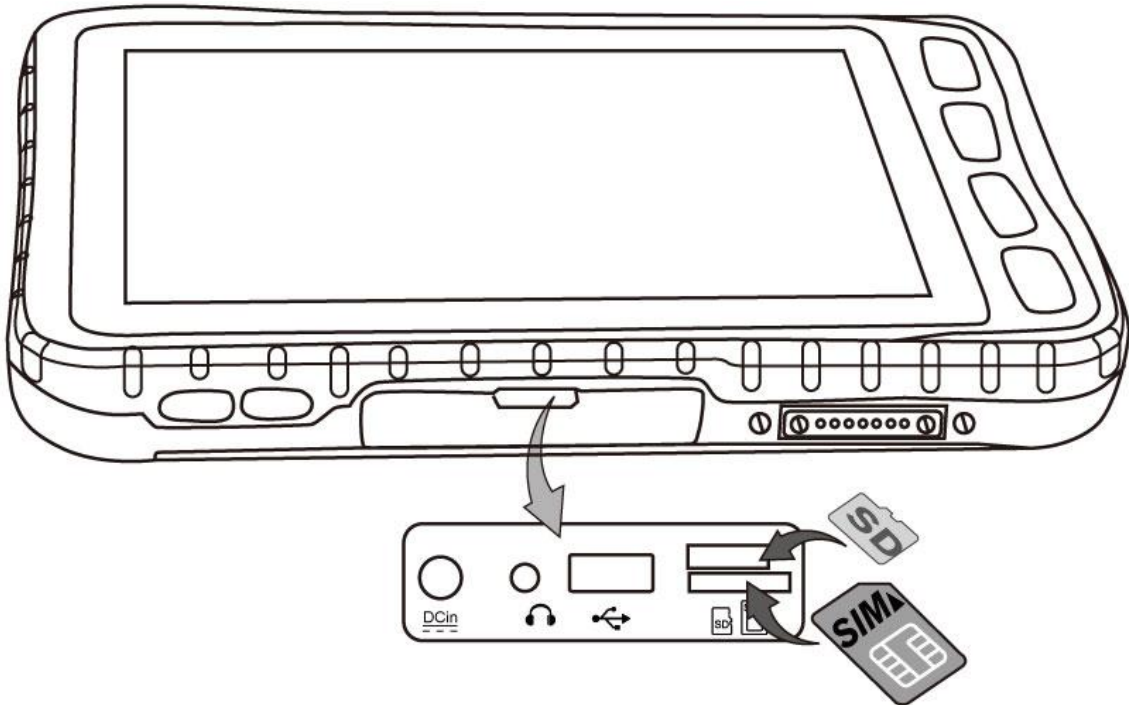

2. Insert the SIM card (with the gold parts facing up and cut-off corner facing in) in the direction of the arrow as shown in the figure.
3. Pick and raise the SD card holder up in upright position and then put the SD Card into the socket.
4. Close the I/O cover.



**Note :**

- Please make sure your device is powered off before swapping SIM cards.
- Notice if your device has the hot swap feature, when the battery is removed the device will not power off. You need to power off in operating system.



## 1.6.2 Battery Installation



### Caution

- The lithium battery used in this tablet may swell after being charged/ discharged many times, but there is no problem regarding safety.
- Continued use in such a state may result in the battery getting jammed, so please stop using the battery, and purchase a new one.

### Inserting the standard Battery Pack into the device:

1. Disconnect AC adapter and power cord from the device.
2. Turn the device over, back facing up.
3. Push the battery latch.
4. Insert the battery on the connector-pins side first, and then lower the battery into the battery compartment. Continue to hold the Battery Release Slider before battery is fully inserted.

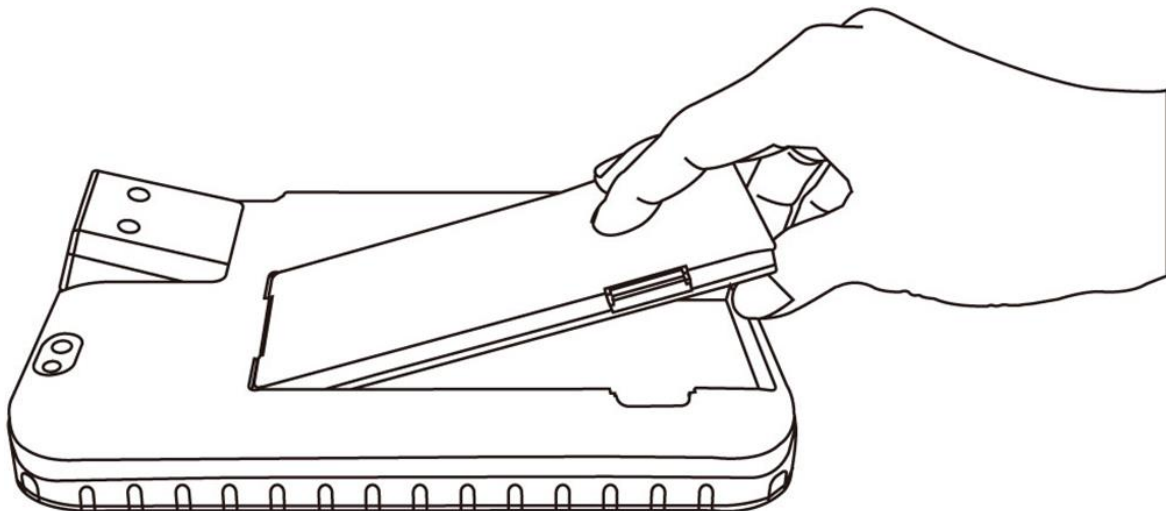

### Caution

Do not insert your fingers into contact hole when inserting the battery.

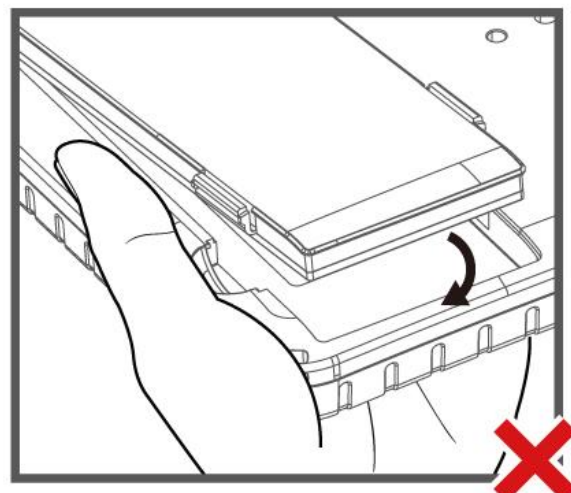
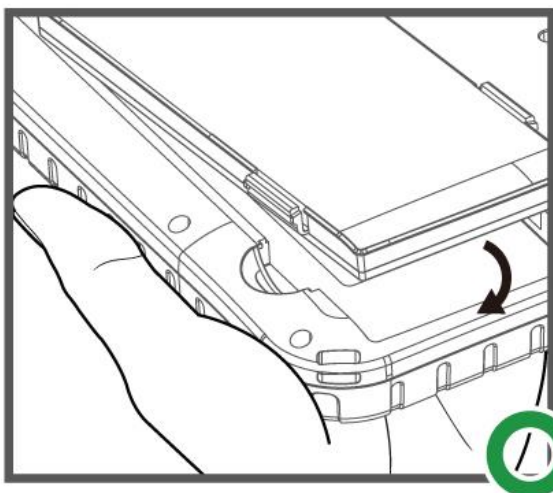

### Removing the Battery Pack:

1. Power off the PDA. Disconnect any cords connected to the device.
2. Turn the PDA over, back facing up.
3. Push Battery Lock Latch to the “Unlocked” position.
4. Lift the battery out using the opening on side of battery compartment.

### 1.6.3 Hot Swapping Batteries

If your device has the hot swap feature, you can swap batteries without powering off your device.



#### **Note:**

- When hot swapping the battery the system will enter suspend mode.
- Don't remove the battery for more than 30 seconds in hot swap mode or press the battery detector to avoid shutdown.

### 1.6.4 Charging the Battery

Charge the battery before using the PDA for the first time, charge the battery until the LED indicator turns solid green. To charge the M700DM8, use a cable or a docking with appropriate power supply.

| LED Status             | Indicator  |
|------------------------|--|
| OFF                    | M700DM8 is not charging or not properly connected  |
| Solid Red              | ● Charging in progress   |
| Continuously Flash Red | ● Indicates low battery status (below 15%*)<br><i>*Connect to the power source or the system may shut down</i>   |
| Twice Flash Red        | ● Not enough power for the device to turn on<br><i>**Charge the device until the LED indicator becomes solid red (Indicates the battery is charged more than 3%)</i> |
| Solid Green            | ● 100% Battery life, charging complete   |
| Solid Blue             | ● Device is starting up  |

#### **To charge the battery:**

1. Connect the power supply output connector to the input power port on the DC Jack cable.
2. Remove the protective rubber and connect the DC Jack cable to the side of M700DM8. The battery charge LED indicates the battery charging status.

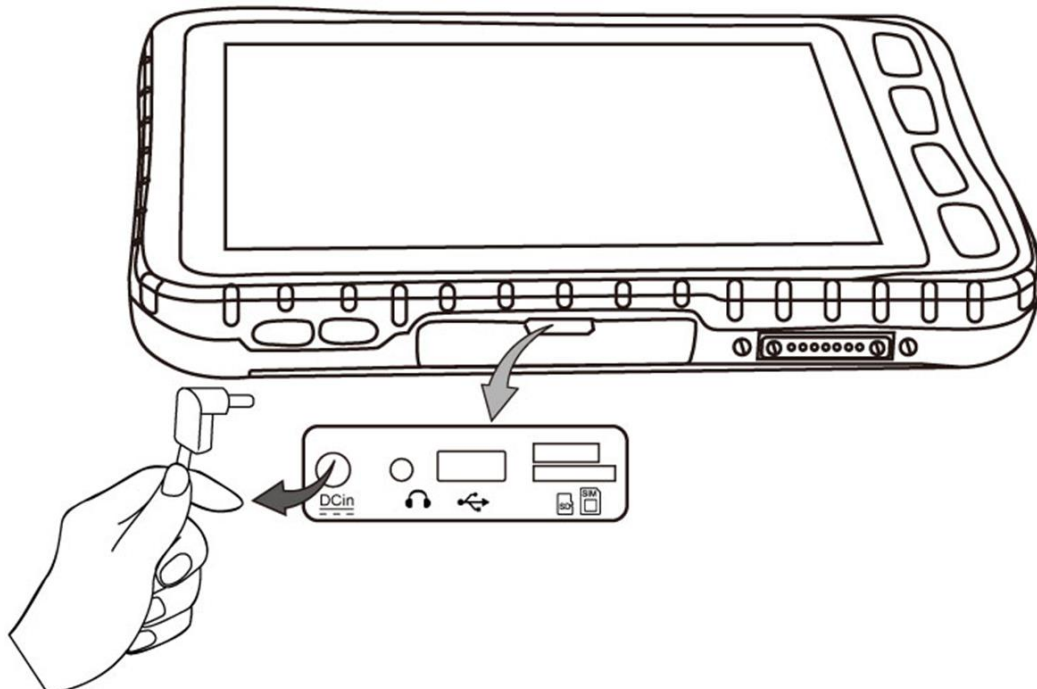

## 1.7 Turning On and Off the Device

This section describes how to turn on/ off the device.

### 1.7.1 Turning On

1. Press and hold the power button for 3 seconds, located on the top side of the unit.
2. When the device vibrates, release the power button. The LED Indicator will be solid blue during the launching process. The desktop screen will then be displayed once operating system has been launched.



**Note:**

For power saving purpose, please enable Connect to PC in Accessibility settings. When connected to PC external 4G, USB and LAN on Docking will be disabled.

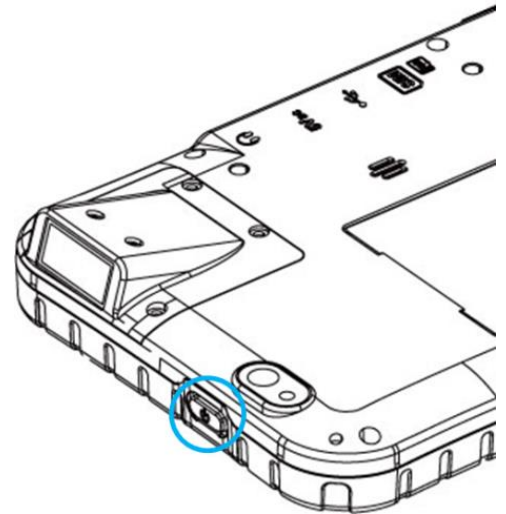

### 1.7.2 Turning Off

1. To turn off the device, press and hold the power button until the options menu appears, tap the **Power Off**.
2. User can also use the options menu to put the device into silent or airplane mode, see features table.

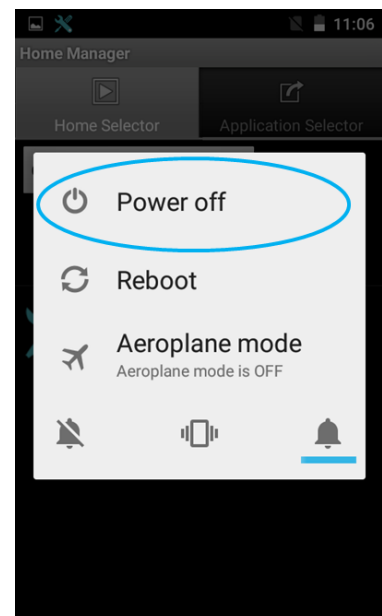

## 1.8 Resetting to Factory Defaults

To reset the device to factory defaults:

1. Tap **Menu** , then tap **Settings** .
2. In the **Personal** tab, tap **Backup & Reset**.
3. User can select to back up application data, Wi-Fi passwords and other settings to Google servers by tapping **Backup My Data**.
4. Tap **Factory Data Reset** to reset the tablet.

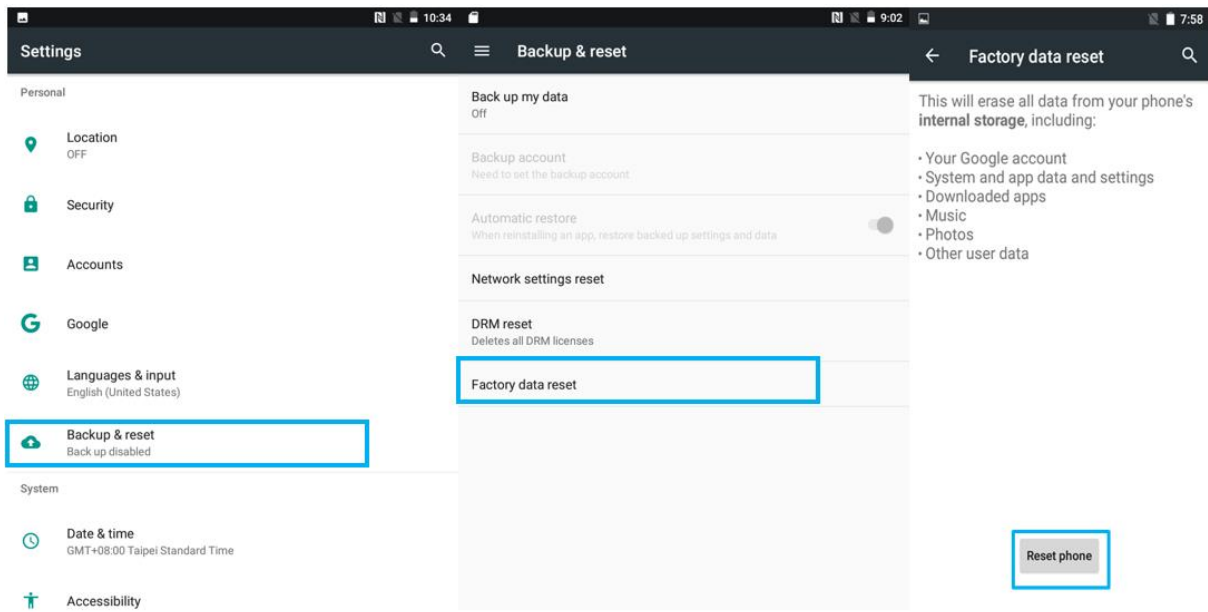

5. Read all the available information and then check Erase storage if user wants to erase all the data in storage such as music or photo.







## **Chapter 2: Using the Tablet**

This chapter explains how to use the buttons, status icons, and controls on M700DM8 tablet running on Android 7.0 Operating System and provides instructions on entering and capturing data.

---

## 2.1 Using the Touch Screen

The touchscreen supports the core gestures for Android.

| Gesture            | Action  | Description   |
|--------------------|---|---|
| Tap                |    | To select or activate something   |
| Tap & Hold         |    | Touch and hold an item on the screen by touching it and not lifting your finger until it respond  |
| Touch, Hold & Drag |    | Touch and hold an item for a moment and then without lifting your finger, move your finger on the screen until you reach the target position. i.e. moving the apps around the home screen |
| Swipe or slide     |    | Quickly move the finger across the surface of the screen. i.e. slide a lock screen to open the lock   |
| Double-tap         |   | Tap quickly twice on a webpage, screen, or App to zoom  |
| Scale              |  | Place two finger on the screen and pinching them together   |
| Rotate             |  | Two-finger press, simultaneously orbit both fingers around the center point, lift.  |

## 2.2 Waking Up the Tablet

If you do not use the tablet for a while, the screen dims and then darkens to conserve the Battery. To wake up the tablet:

1. Press the Power button on the top side of the tablet.
2. Drag the lock icon  upwards to unlock the screen.

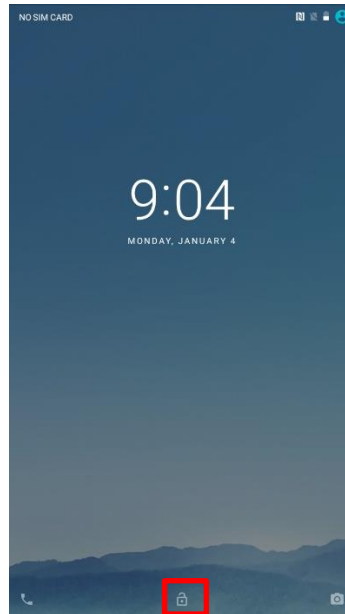

## 2.3 Using the Home Screen

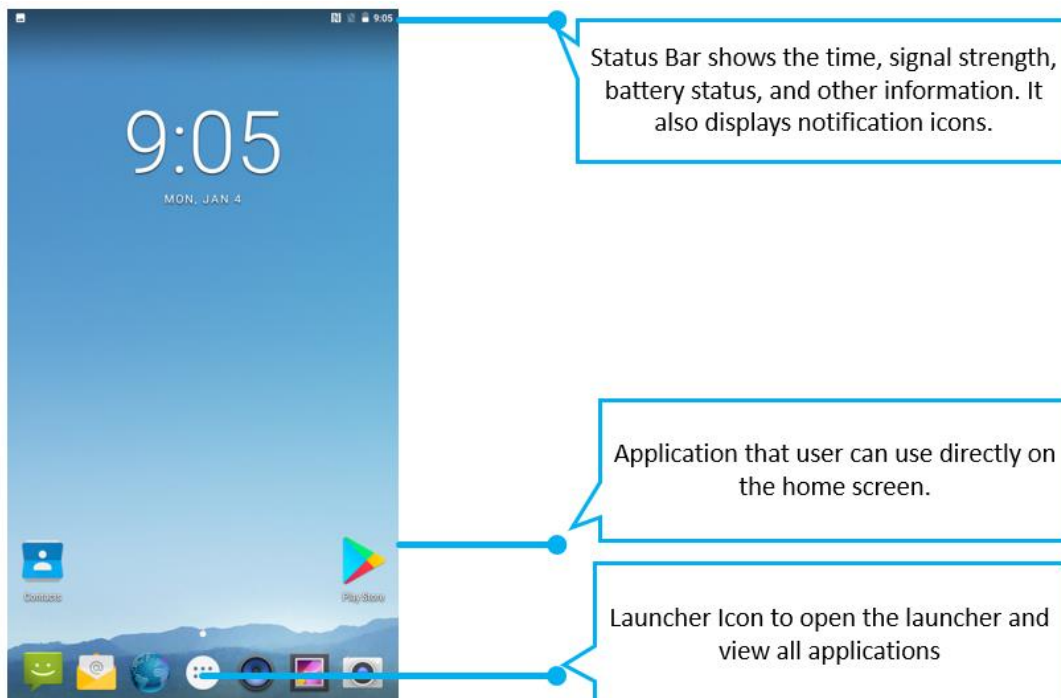

Home screen is the starting point to access all the features on your tablet Device. It displays application icons, widgets, shortcuts, and other features. User can personalize the home screen. See “Personalizing home screen”.



## 2.3.1 Personalizing Home Screen

User can add application icons, shortcuts, widgets, and other items to any part of any Home screen where there is free space. User can also switch the wallpaper.

### To change wallpaper on the HOME SCREEN:

1. Tap **MENU** , and then open **Settings** .
2. In the Device tab, tap **Display > Wallpaper**.
3. In the Wallpaper menu select the location of wallpaper, and then tap the type of item you want to add.

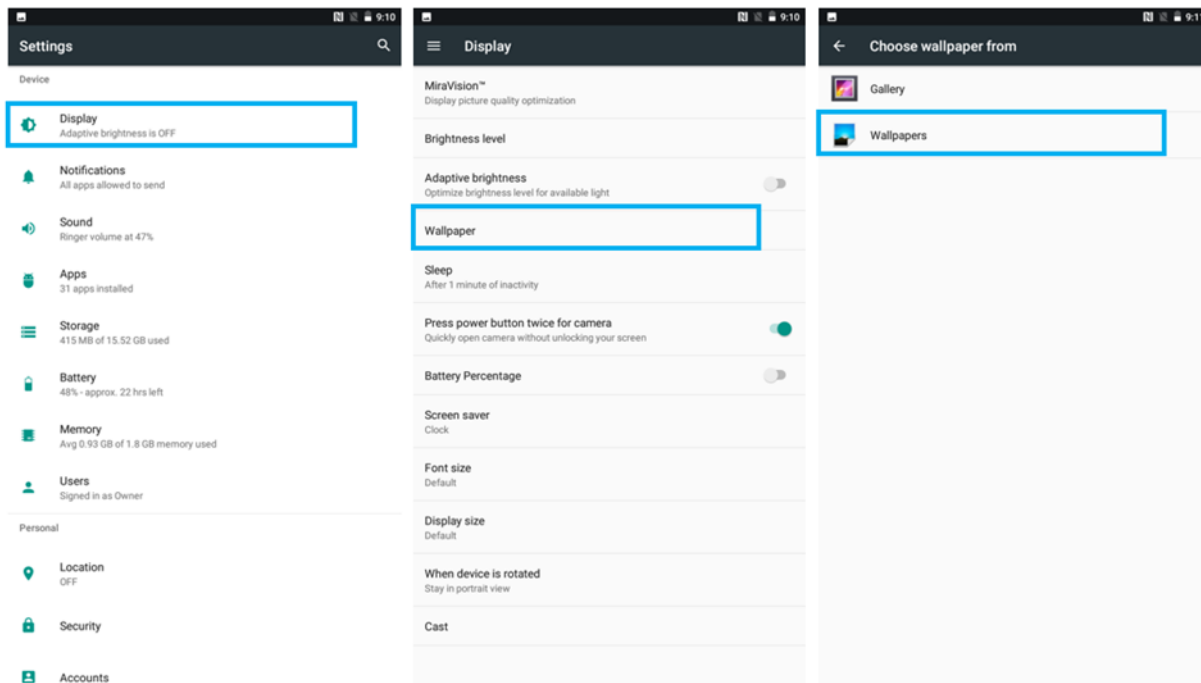



**To move an item on the HOME SCREEN:**

1. Tap and hold the item you want to move, until it can be moved.
2. Drag it to a new location on the screen.
3. Place the item where you want to put it and lift your finger.

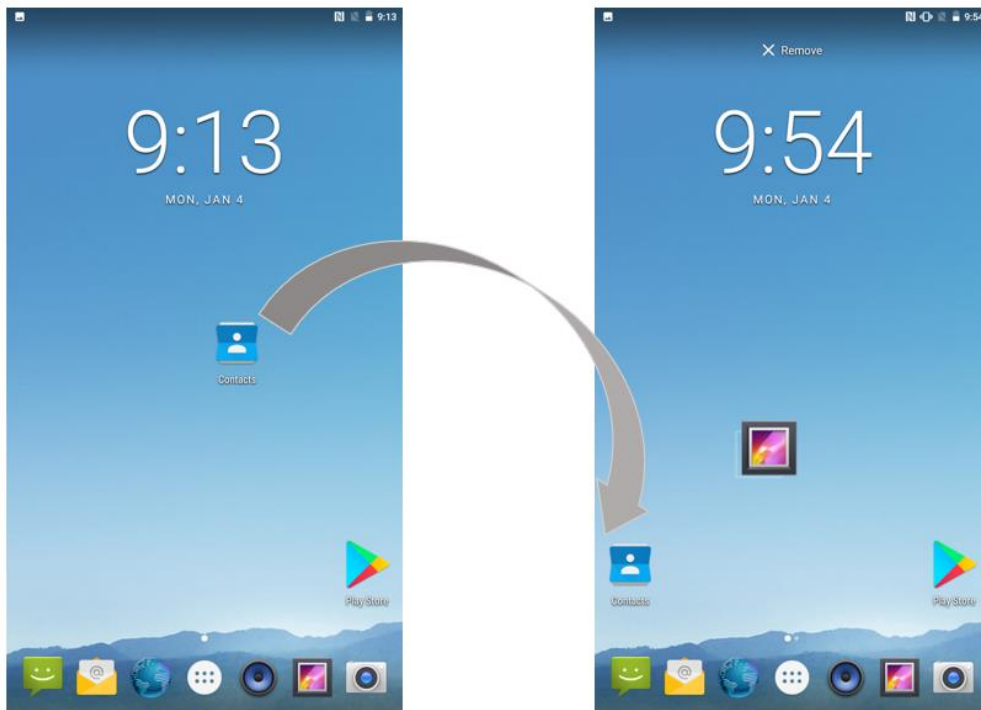
**To remove items from the HOME SCREEN:**

1. Tap and hold the item you want to remove. The launcher icon will show **Remove** on the top of the screen.
2. Drag the item you want to remove to the Remove icon.
3. When the icon turns red, release your finger.

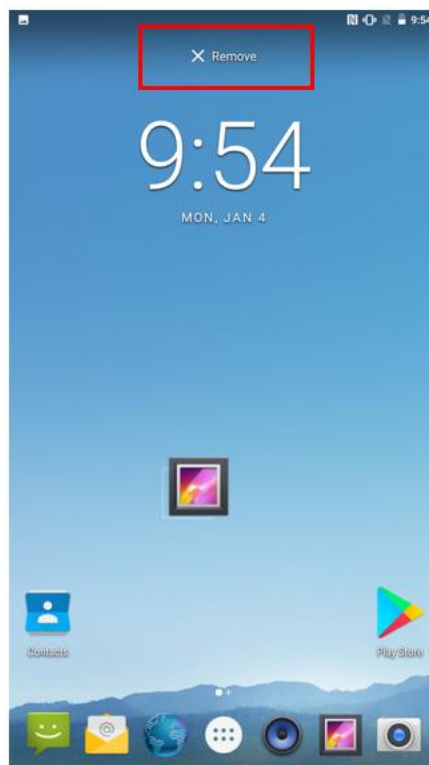

## 2.3.2 Viewing other parts of the Home Screen

1. Slide your finger left or right across the Home screen. Extensions to the Home screen provide extra space for APPS, shortcuts, and other items.

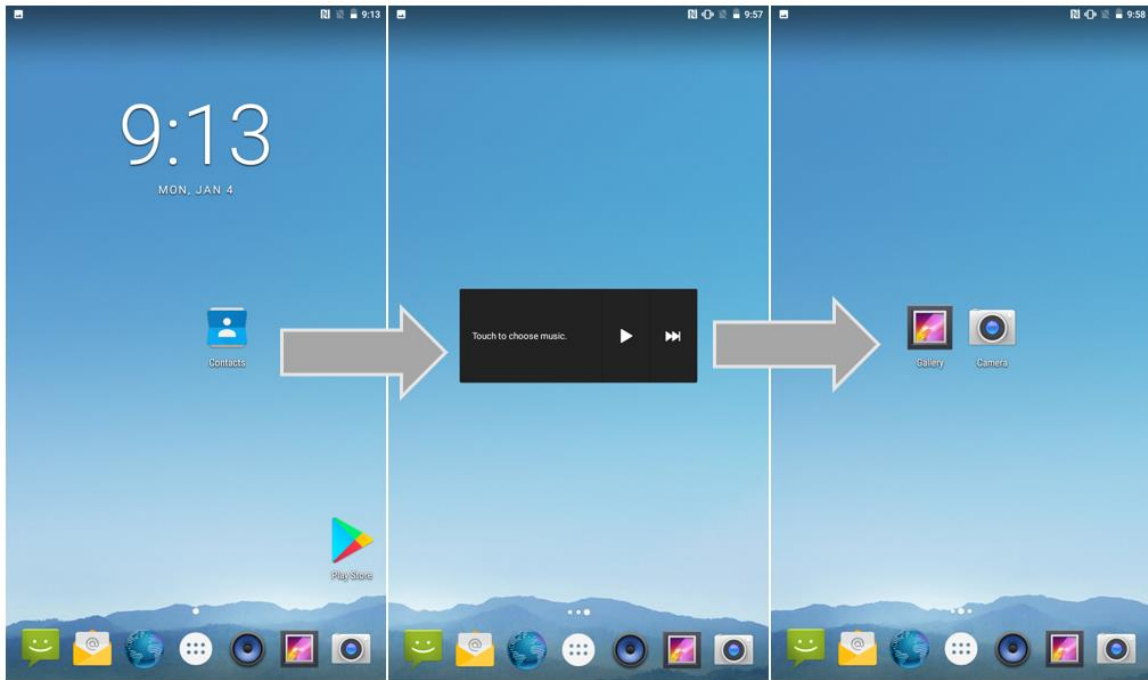

2. Tap the launcher icon  to view the entire APPS of the device.

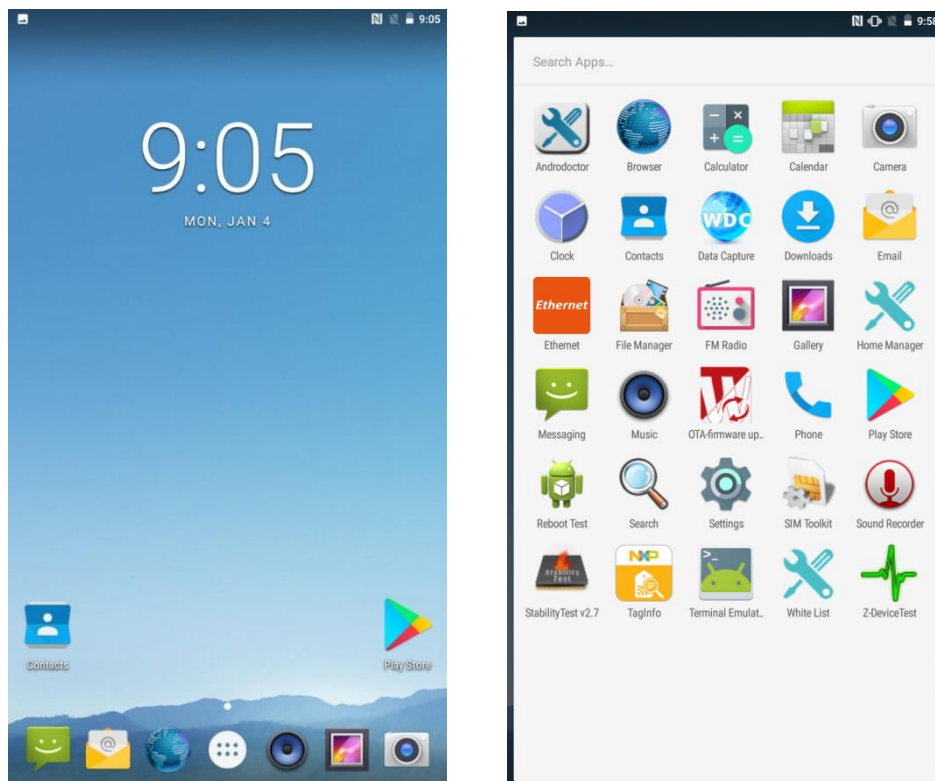

The status bar appears at the top of every screen. On the left are notification icons and on the right are status icons, along with the current time.

## 2.4 Status and Notification Icons



### 2.4.1 Notification Icons

Pull down from the left top of the screen to get the notifications area. The following icons indicate that you have received notification.

|  |                                |  |                                  |
|--|--------------------------------|--|----------------------------------|
|  | New email message              |  | Incoming call                    |
|  | New text or multimedia message |  | Missed call                      |
|  | Alarm is set                   |  | Speakerphone is activated        |
|  | Upcoming event                 |  | Phone microphone is muted        |
|  | Data is syncing                |  | Downloading data                 |
|  | Problem with sign-in or sync   |  | Phone is connected via USB cable |
|  | A screenshot is captured       |  |                                  |

### 2.4.2 Status Icons

Pull down from the right top of the screen to get the notifications area. The following icons indicate the status of your device, for example if users are connected to a Wi-Fi network that is not connected to the internet, the network icons are appears in white color.

Status icons that appear in the status bar are as follows:

|  |                                   |  |                                  |
|--|-----------------------------------|--|----------------------------------|
|  | Connected to GPRS mobile network  |  | Bluetooth is on                  |
|  | Connected to 1xRTT mobile network |  | Connected to a Bluetooth device  |
|  | Connected to EDGE mobile network  |  | No SIM card installed            |
|  | Connected to 3G mobile network    |  | Vibrate mode                     |
|  | Connected to 4G mobile network    |  | Ringer is silenced               |
|  | Mobile network signal strength    |  | Battery is very low              |
|  | Searching for a network signal    |  | Battery is low                   |
|  | No signal                         |  | Battery is partially drained     |
|  | Connected to a Wi-Fi network      |  | Battery is full                  |
|  | Roaming                           |  | Battery is charging              |
|  | Airplane mode                     |  | Receiving location data from GPS |

## 2.5 Using the On-Screen Keyboard



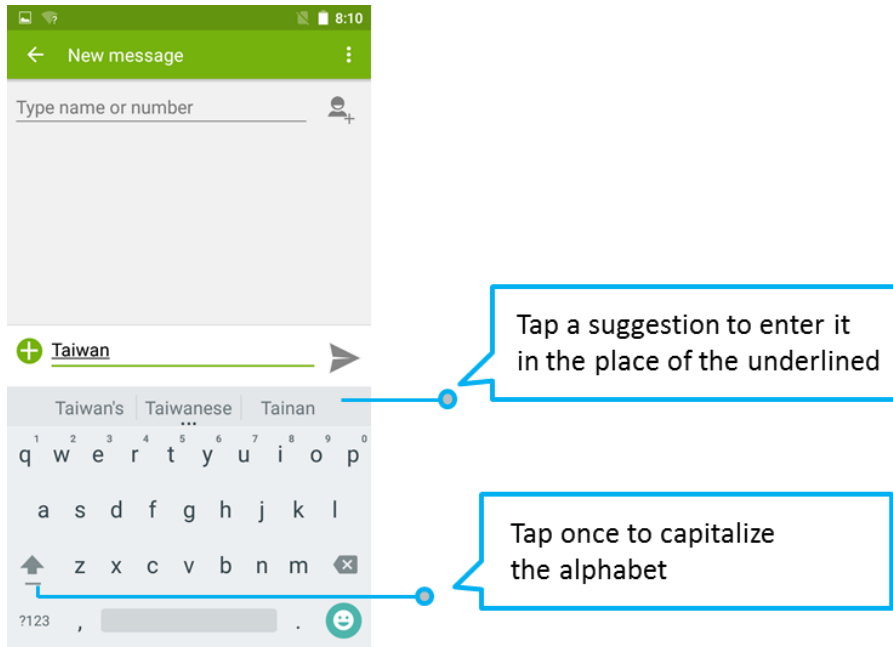

User will be able to enter text using the On-Screen Keyboard. Some applications will launch the keyboard automatically. In others, user needs to touch a text field where user wants to enter text to launch the keyboard.

### 2.5.1 Entering Text

1. Open a text field, in this example we used Messaging  to compose a message. The On-Screen Keyboard opens.



*\*If user taps in a text field which already contains text, the insertion point is set where user tap and the cursor appears. User can drag the cursor to pick exactly where you want to add more text. User can also select a word to copy, cut and paste it. See "[Editing Text](#)".*

2. Tap the delete key  to erase characters to the left of the cursor.
3. Tap  to enter numbers. Tap  to return to letters.
4. To enter symbols and other characters, tap and hold one of the top-row keys and slide your finger up to the list of the options. Lift your finger when you find your selection.
5. To view additional symbols, tap  on the numeric keyboard.

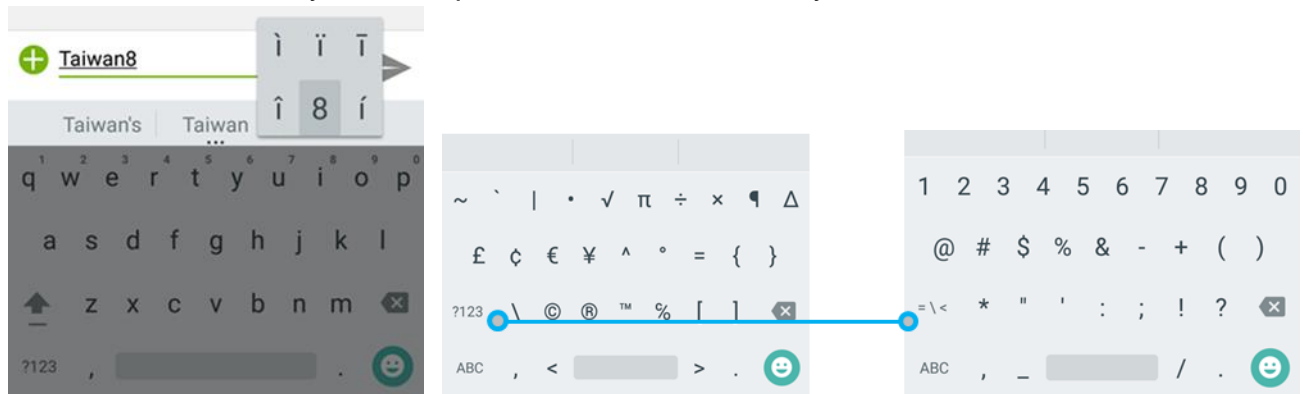

6. To close the On-Screen keyboard, press the back button .



## 2.5.2 Editing Text

### To select text:

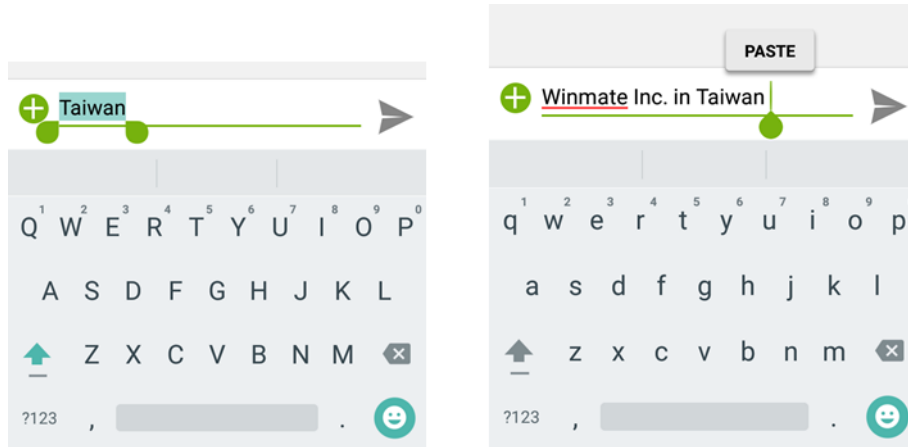
1. Double-tap the text you want to select.
2. Tap  to select all the sentences in the menu that appears, the selected text is highlighted in blue, with a tab at each end of the selected word.
3. Drag selection tab to expand or reduce the range of the selected text.



### To Cut or Copy Text:

1. Select the text to cut or copy, see the section above [“To select text”](#).
2. Tap  or  in the Edit text menu.
3. If you select , the selected text is removed from the text field; it is stored in temporary area so that you can paste it into different text field.

### To Paste Text:

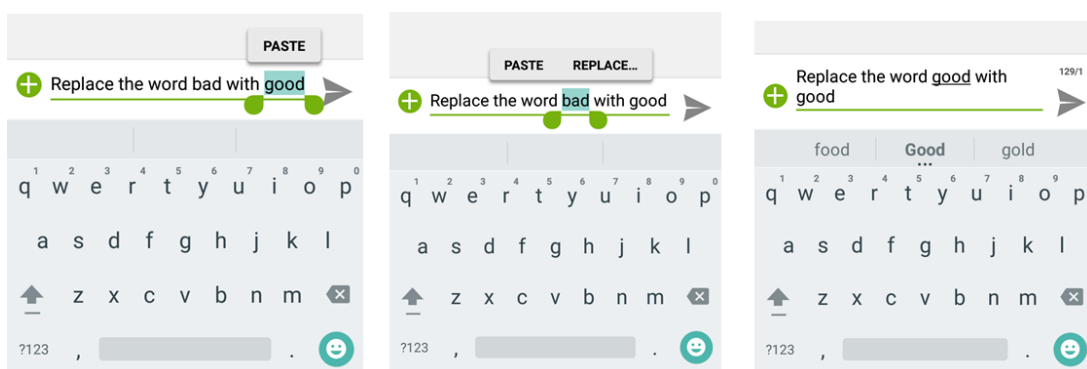

1. After Cut or Copy the text, see the section above [“To Cut or Copy Text”](#)
2. Place the cursor in the text field where you want to paste the text, user can paste text that you copied from one application into a text field in any application.
3. Tap and hold into the location that you want to paste. Tap **PASTE** in the menu that opens

or user can also tap  to replace the existing text with copied text.



## 2.6 Display Settings

Use the display settings to configure brightness and other screen settings.

1. Tap **MENU**  and then tap **Settings** .
2. In the **Device** tab, tap **Display**:
  - **Display**
    - **MiraVision™** - to display picture quality optimization options.
    - **Brightness level**– for adjusting the brightness of the screen.
    - **Adaptive brightness** – to optimize brightness level for available light
    - **Wallpaper** – to select wallpaper
    - **Sleep** – to set up the device's sleep mode after the specified period of inactivity
    - **Press power button twice for camera** – Quickly open camera without unlocking your screen
    - **Battery Percentage** – to control battery percentage display.
    - **Screen saver** – to control what happens when the tablet is docked and/or sleeping, turn screen saver on
    - **Font size** – Make the text on screen smaller or larger
    - **Display size** – Make the items on your screen smaller or larger. Some apps on your screen may change position.
    - **When device is rotated** – for switching the orientation of the screen when user turns the device sideways or upright.
    - **Cast** – allows displaying whatever is visible on the device's screen on another screen, mostly wirelessly using Wi-Fi as a medium for sharing the screen.

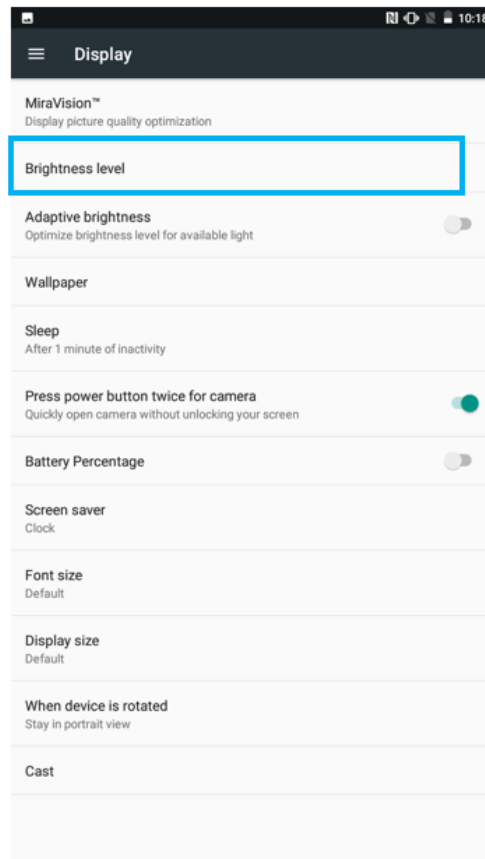
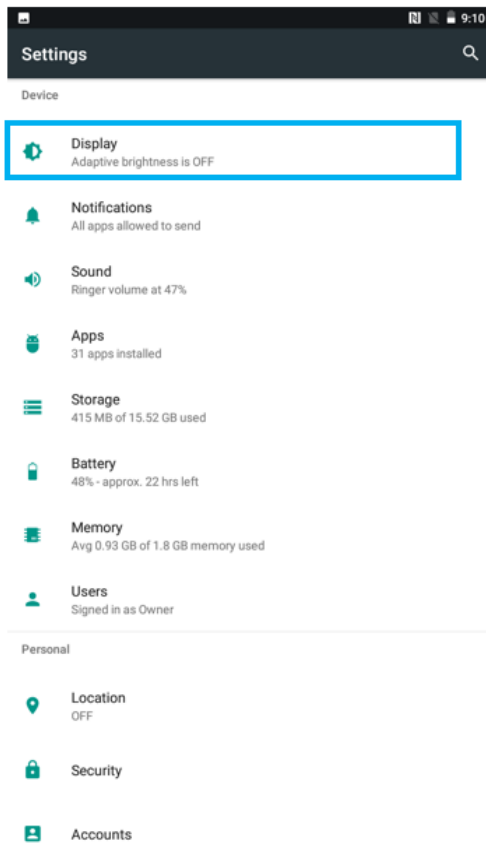

**Note:**

For the longest battery life between charges, use the shortest Sleep time.

## 2.7 Audio Profile Settings

Use the sound settings to configure how and at what volume the tablet rings, vibrates or alerts user in other ways when user receive a call, receive a notification or an alarm sounds.

### 2.7.1 Sound Settings

1. Tap **MENU**  and then tap **Settings** .
2. In the **Device** tab, tap **Sound & Notification** and then user can select General, Silent, Meeting or Outdoor profile.

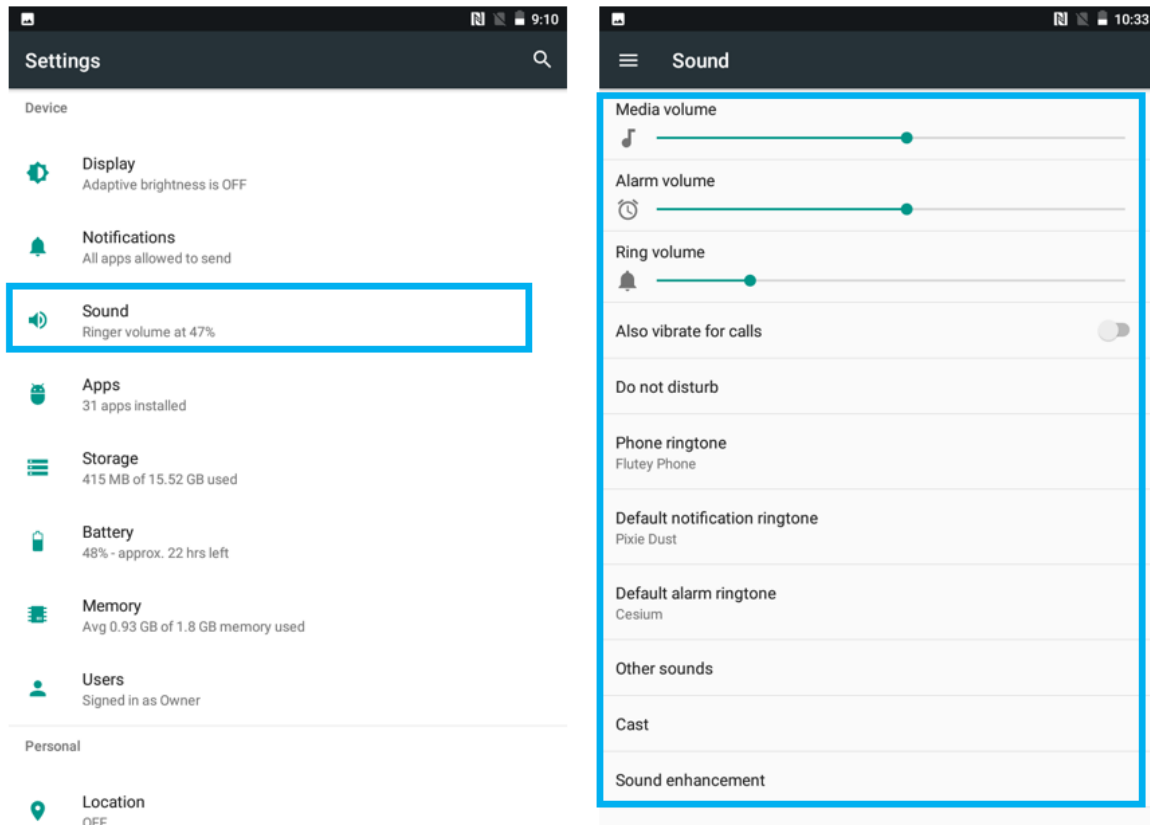

### 2.7.2 Adjusting Volume

1. Press the volume keys to change the ring volume (On Home screen) or earpiece volume (during a call).





2. Press the volume key to set up Vibration mode.





## 2.8 Language and Keyboard Settings

Use the Language & keyboard settings to select the language for the text on your tablet and for configuring On-Screen Keyboard, including words that you have added to its dictionary.

1. Tap **MENU**  and then tap **Settings** .
2. In the **Personal** tab, select **Language & Input**.
  - **Language** – to open the language screen, where user can select the language to use for the text on the device.
  - **Spell Checker** – to activate Android Spell Checker (AOSP) and check to correct misspelled words.
  - **Personal dictionary**– to open a personal dictionary.
  - **Keyboard & input methods**
    - **Virtual Keyboard** – to apply the onscreen keyboard that is included with user's device. Default Android Keyboard (AOSP).
    - **Physical Keyboard** – allows the user to apply physical keyboard settings if connected.
  - **Appearance & layouts**
    - **Theme** – to select the theme of layout.
    - **Custom input styles** – user can select custom input style, such as QWERTY keyboard.
    - **Enable split keyboard** – toggle to activate split keyboard layout.
  - **Text Correction**
    - **Personal dictionaries**
    - **Add-on dictionaries**
    - **Block offensive words** – disable suggesting potentially offensive words
    - **Auto-correction** – spacebar and punctuation automatically correct mistyped words.
    - **Show correction suggestions** – display suggested words while typing.
    - **Personalized suggestions** – learn from your communications and typed data to improve suggestions.
    - **Suggest contact names** – use names from Contacts for suggestions and corrections.
    - **Next-word suggestion** – use previous word in making suggestion.
  - **Advanced**
    - **Keypress vibration duration**
    - **Keypress sound volume**
    - **Key long press delay**
    - **Emoji for physical keyboard**
    - **Show app icon**

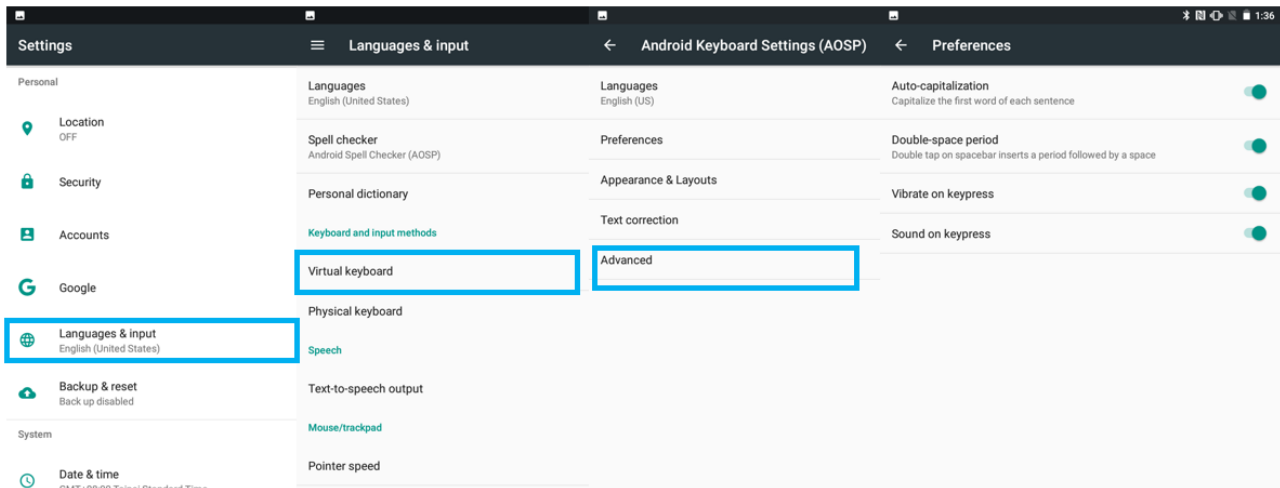

## 2.8.1 Changing the Keyboard Language

The current keyboard language is displayed on the Space key and user can switch languages.



1. Tap and hold the space key
2. Without lifting the finger, slide it to the left or right until the language you want to use appears in the center of the small window above the Space Key.
3. Lift the finger to change the keyboard language.

## 2.9 About Phone

About Phone includes information about user's device.

- **System Update** — provides information regarding the local or online update of your devices.
- **Status** — opens the status screen with a list of information about battery, network, signal strength and other details.
- **Legal Information** — lists details about the model number, Android Version, Baseband version etc. this information is useful if user need to work with support team.
- **Model number** – displays the model name of the current device.
- **Android version** – displays the current Android operating system version the device running

To access the information about the phone:

1. Tap **MENU** 
2. Tap **Settings** 
3. Scroll down to **System**, and then tap **About phone**.

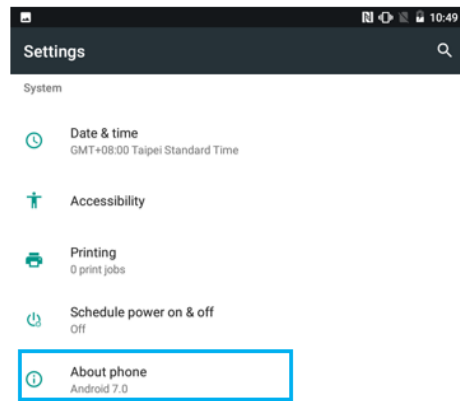

## **Chapter 3: Winmate Home Manager**

Every M700DM8 series tablet comes with preinstalled APP named Winmate® Home Manager (WHM). This application lets the device manager to lock the launcher. When the launcher is locked the user can only use one application assigned by the device manager.

---

## 3.1 How to Lock Applications

### Step 1

- In the main APPS window, select the Home Manager APP and enable it.
- Select Home Manager to start your settings.
- Go to **Password Manager** and set your own password for this APP. The default password is “0000”.

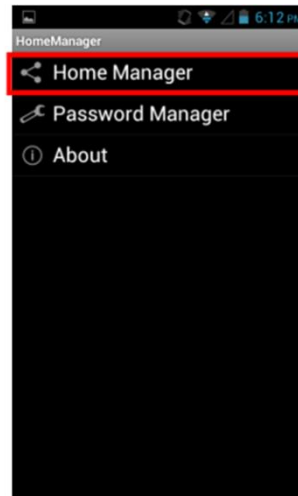
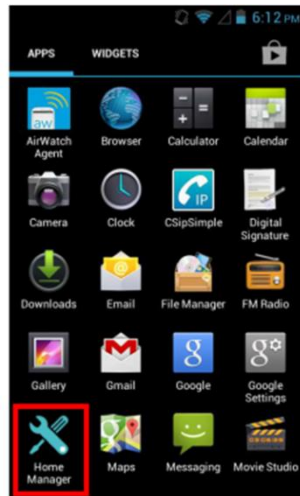

### Step 2

- Go to “**Application Selector**” and choose an Application to be locked.

*Example: Select the Calendar AP.*

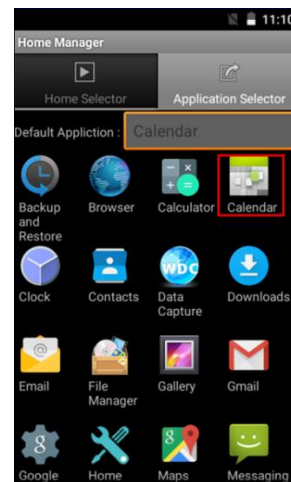

- Step 3** Go back to “**Home Selector**” and press “**Clear and Reset Default Home**”.

**Step 4** Select “**Restrict Home**”, and then restart the tablet.

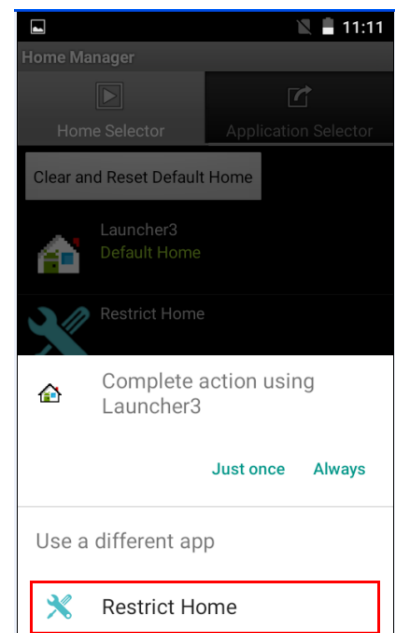
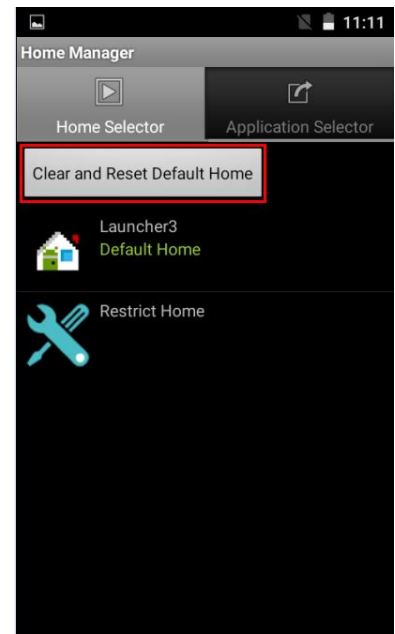

**Step 6** System will ask to select “**Just once**” or “**Always**” to use this launcher, please select “**Always**”.

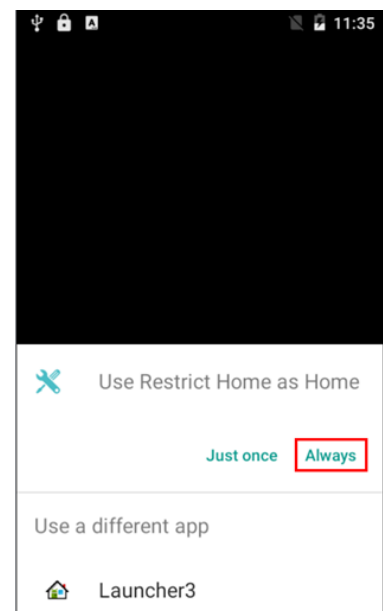

The system will automatically start the application which you selected and lock it.

Any time you press home key or back key, the system will go back to the same application which you have selected.

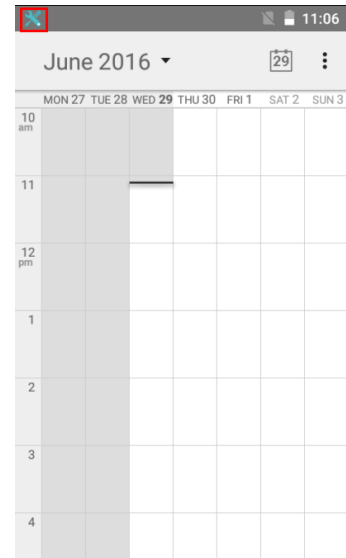

## 3.2 How to Unlock Applications

**Step 1** Slide down the top bar and press “**Home Manager**” icon then you can find the menu and please enter the password to login (The default password is “**0000**”).

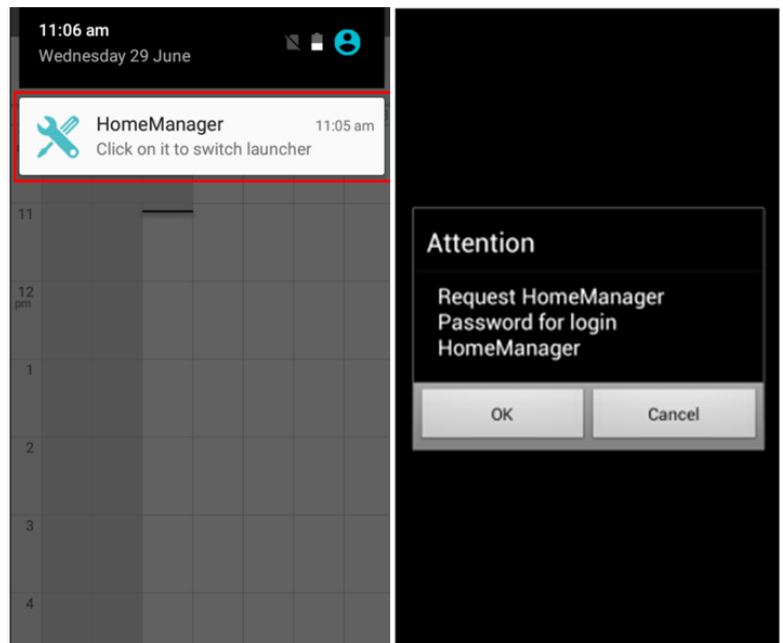

**Step 2** Go back to “Home Selector” and press “Clear and Reset Default Home”.

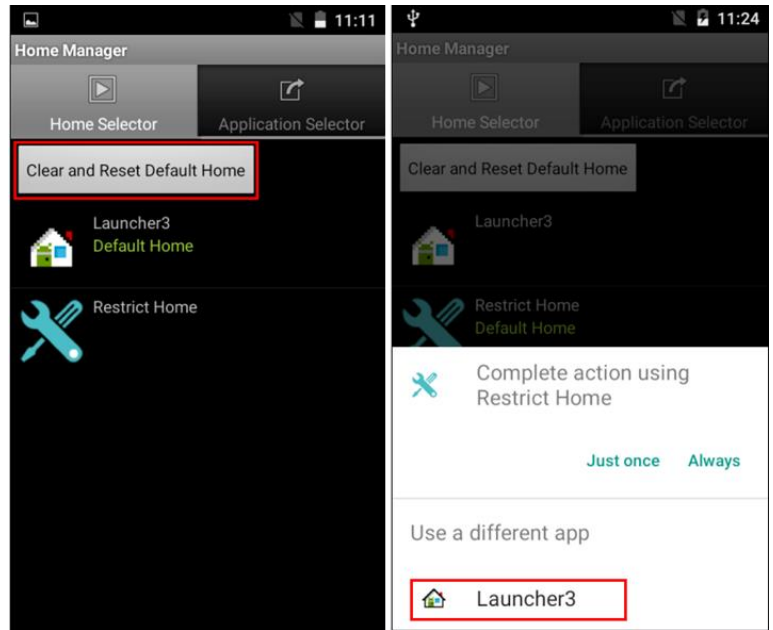

**Step 3** Restart the system and you will go back to the normal Launcher.





### 3.3 How to Change Password

**Step 1** Go to **Password Manager** and set your own password for this APP.

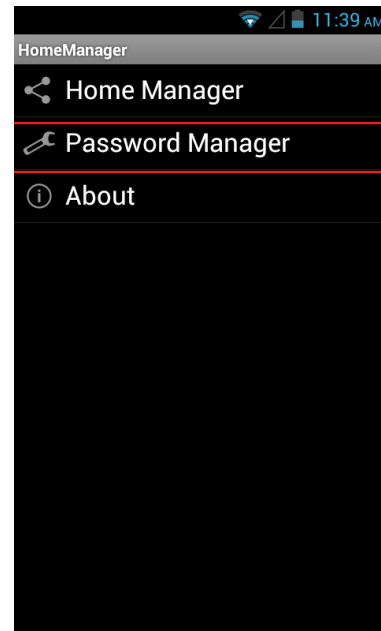

**Step 2** The default password is "0000". Enter a new password in **New Password field**, and then tap **Change Password**.

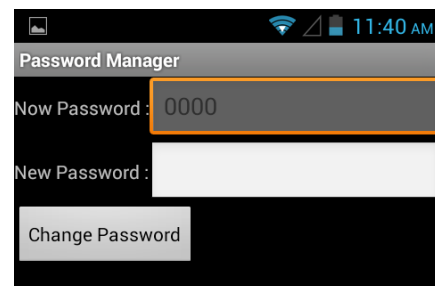

## **Chapter 4: Networks and Wireless Devices**

This chapter explains how to connect tablet to network and peripheral devices.



## 4.1 Connecting to Mobile Networks

When users install a SIM card from service provider to the M700DM8, the device is configured to use the provider's networks for voice calls and for transmitting data. Different locations may have different mobile networks available; user may need to configure M700DM8 to use certain networks.



### Note:

To obtain faster networks configure the device to 4G.  
To extend the life of battery user can use 2G network.

### 4.1.1 Checking the Network (GPRS/3G/4G) Connection



1. Tap and then tap **System Settings** .
2. Tap **More** in the **Wireless & networks**, and then tap **Mobile networks**.
3. Tap **3G/4G Service** to check the network connection.



### Important:



Do not change the parameters of the access point to prevent inability to access network sources.

### 4.1.2 Turning on Data Service

1. Tap **MENU**  and then tap **Settings** .
2. Tap **More** in the **Wireless & networks**, and then tap **Cellular networks**.
3. Tap **Data connection**.
4. Select the desired network operator to enable the data connection.

## 4.2 Connecting to Wi-Fi Networks

### 4.2.1 Turning on Wi-Fi and Connecting to Wi-Fi Networks

1. Tap **MENU**  and then tap **Settings** .
2. Tap **Wireless & networks** and then select **Wi-Fi** to turn it on .
3. Tap **Wi-Fi**. The device scans for available Wi-Fi networks and displays the list of it. Secured networks are indicated with a lock icon. If the tablet finds a network that you have connected previously, it connects to it automatically.
4. Tap a network to connect to it:
  - If the network is open, you are prompted to confirm that you want to connect it by tapping **Connect**.
  - If the network is secured, users are prompted to enter a password or other credentials.
5. To check the details about the speed, security, address and related settings, tap its name in the Wi-Fi settings screen.

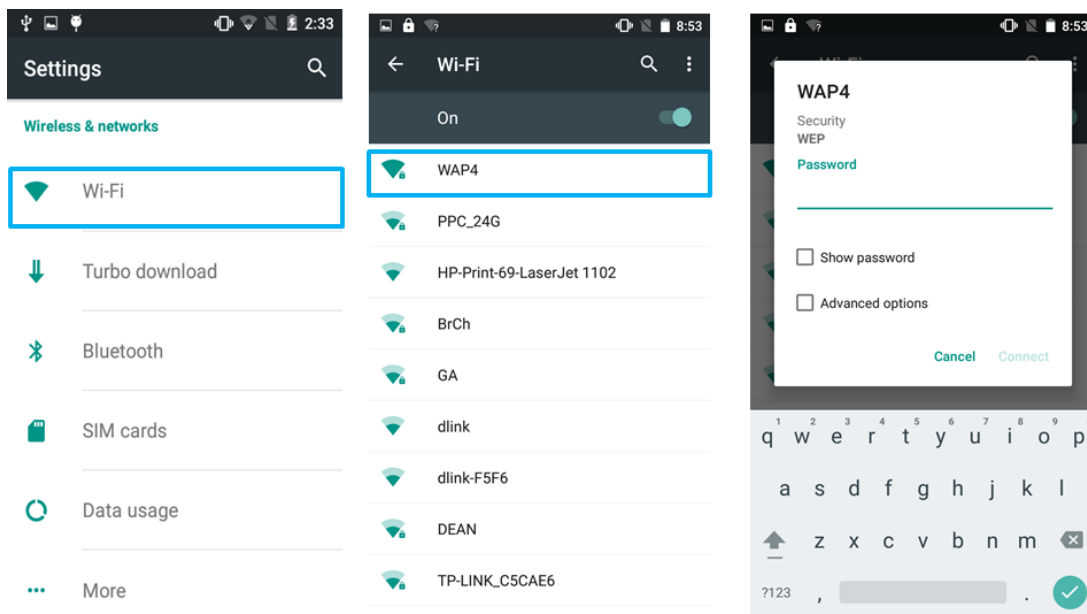

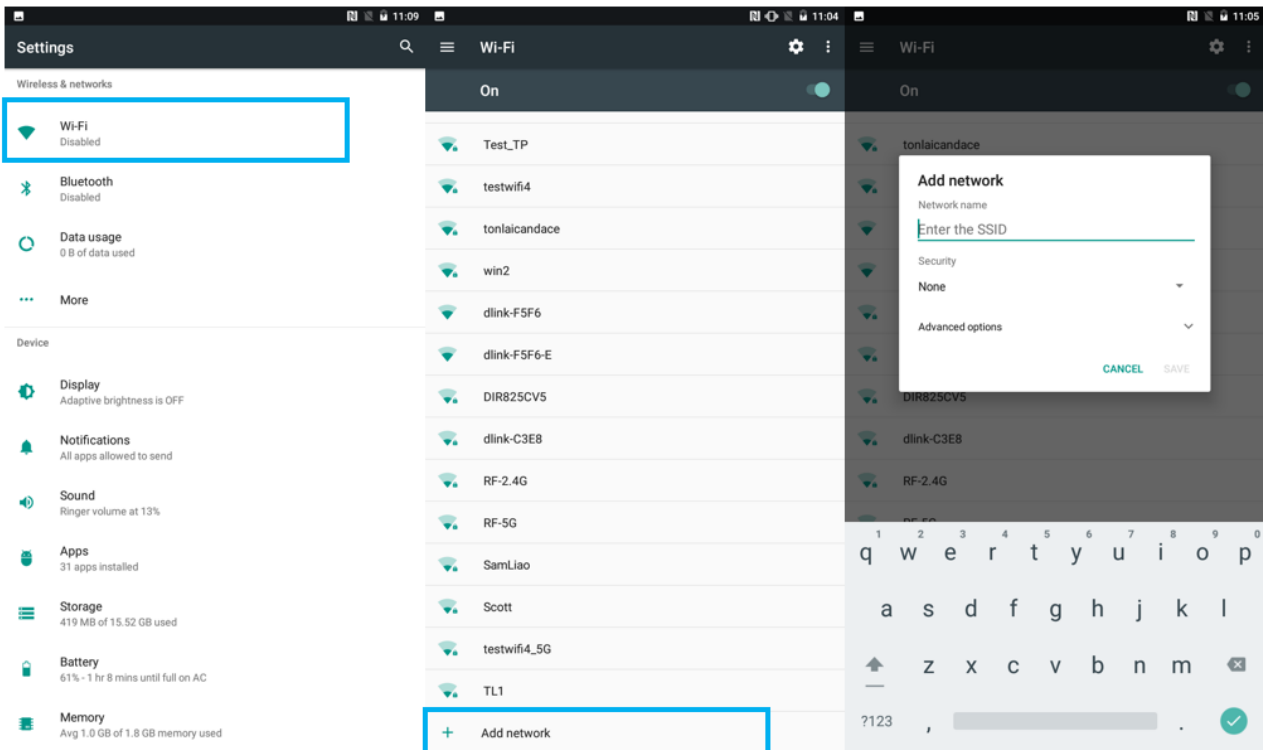

## 4.2.2 Adding Wi-Fi Network

1. Turn on Wi-Fi, in the Wi-Fi settings screen, tap **+ Add network** (at the bottom of the list of discovered networks).
2. Input the SSID (name) of the network, if the network is secured, tap the security menu and then tap the type of security deployed on the network.
3. Enter any required security credentials.
4. Tap **Save**.



## 4.3 Connecting to Bluetooth Devices

### 4.3.1 Turning Bluetooth On or Off

1. Tap **MENU**  and then tap **System settings** .
2. Tap **Wireless & networks** and then select **Bluetooth**.
3. Toggle the on/off switch on the top-right hand side to turn on **Bluetooth**.

### 4.3.2 Connecting to Bluetooth Device

1. Go to **Settings** .
2. Tap **Wireless & networks**, and then tap **Bluetooth**.
3. Toggle the on/off switch on the top-right hand side to turn on Bluetooth.
4. It will automatically scan and displays the IDs of all available Bluetooth devices in range.
5. Tap the **ID** of the other device in the list in Settings to pair them.

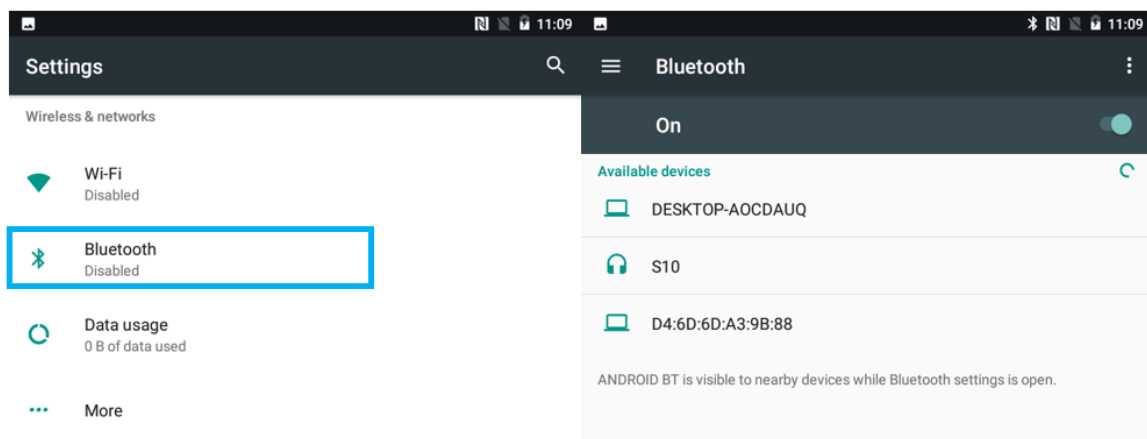

### 4.3.3 Disconnecting Bluetooth Device

1. Tap the device in the Bluetooth settings screen.
2. Tap **OK** to confirm that you want to disconnect.

## 4.4 Connecting to Computer via USB

User can connect their tablet to a computer with USB cable to transfer files between tablet and computer.



### Important:

-When connecting your tablet to a computer and inserting its USB storage or SD card, user must follow the computer's instructions for connecting and disconnecting USB device, to avoid damaging or corrupting files.

-Notice that the M700DM8 cannot be charged via USB.

### 4.4.1 USB Computer Connection

1. Enter setting menu, and enter select "Accessibility", and then check "Connect to PC".

When **Connected to PC** is selected:

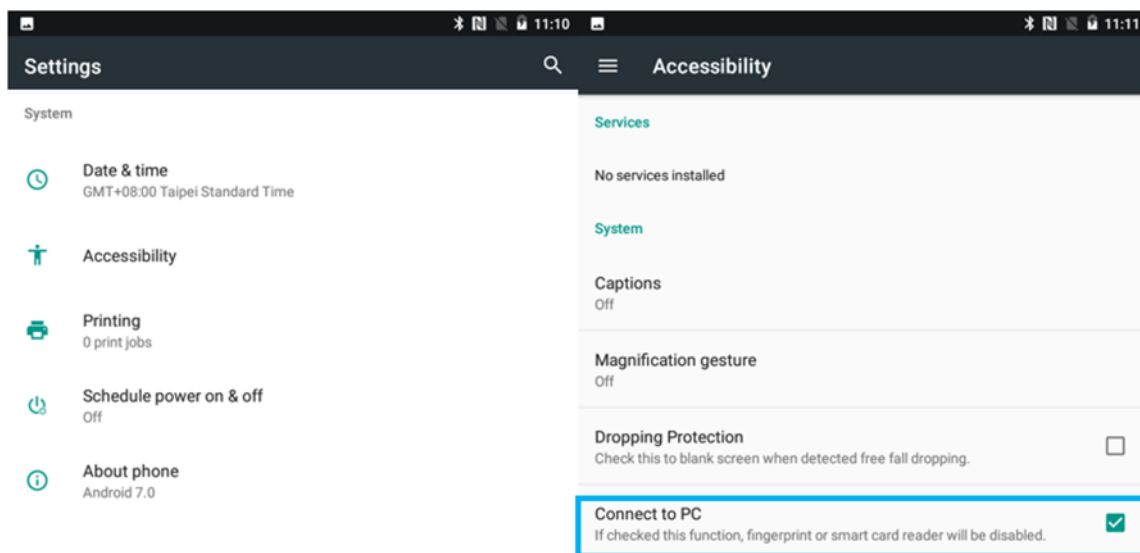

|                                    | Check | Uncheck |
|------------------------------------|-------|---------|
| Micro USB-OTG                      | ✓     | ✗       |
| Micro USB-Host                     | ✓     | ✓       |
| External 4G (U-blox) (If equipped) | ✗     | ✓       |
| Docking (USB & LAN)                | ✗     | ✓       |

2. Connect tablet to the computer via USB connector.
3. In the notifications area **USB connected sign**  will appear.
4. Pull down the notification area to open notification panel.

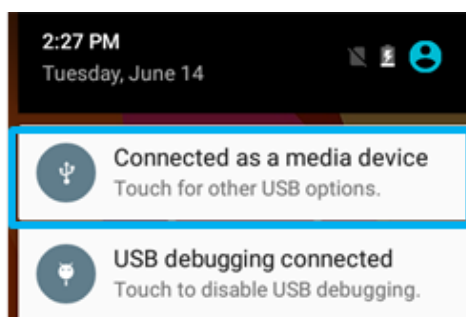

5. Tap this icon  to choose the type of USB connection.
- **Transfer files** –let user transfers files between computer and tablet.
  - **Transfer photos (PTP)** – let users transfer photos or media files if MTP is not supported.
  - **Use device as MIDI** – let users use device as MIDI

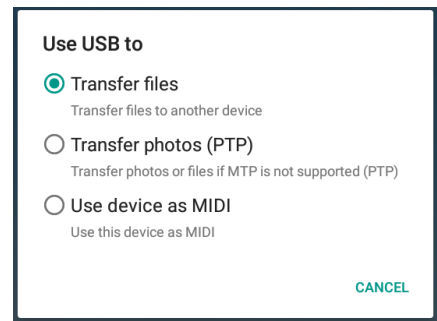

#### 4.4.2 USB Debugging Settings

To permit debugging tools on a computer to communicate with User's tablet via USB Connection.

1. Connect tablet to the computer via USB cable.
2. In the notifications area **USB debugging connect** sign  will appear.
3. Pull down the screen to open notification panel.

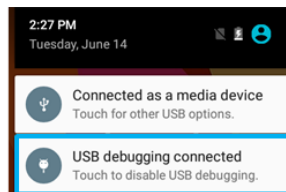

4. Tap **USB debugging connected**.
5. In the **Developer options** user can choose the action to perform.

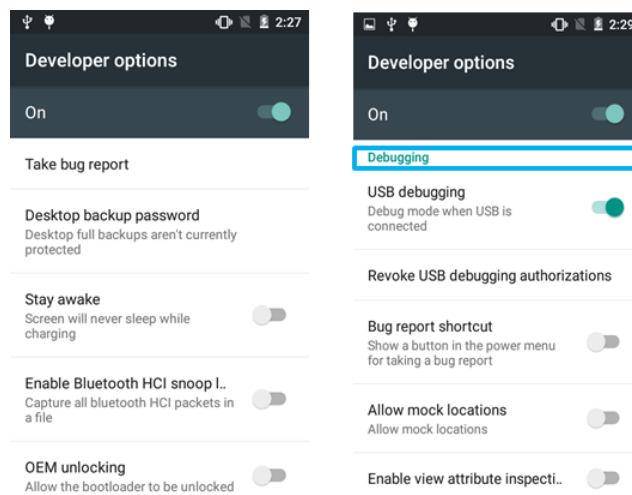

#### Important:

Carefully follow your computer's instructions to un-mount the USB storage or SD card. Disconnect USB device not properly can cause a loss of important data or information.



## Chapter 5: Using Camera

This chapter explains how to use camera to capture photos and videos.



## 5.1 Capturing Photos or Video

Winmate® M700DM8 is equipped with an 8MP Camera on the rear side and a 2MP Camera on the front side, which user can use to capture photos or video.

### 5.1.1 Opening Camera

1. Tap the launcher and then tap **Camera** .



Camera opens in Portrait mode, ready to take a picture or shoot a video.



#### IMPORTANT

Make sure the protective lens cover is clean before taking pictures. A lens cover with smudges from fingers can cause blurry pictures.

### 5.1.2 Taking pictures

1. Adjust the exposure, flash, and other necessary settings. Or leave it automatic.
2. Tap the On Screen Shutter icon .
3. The camera brings the image into focus, when the image is in focus, the focus indicators in each corner will turn green and ready to capture.
4. Tap  to change camera settings.

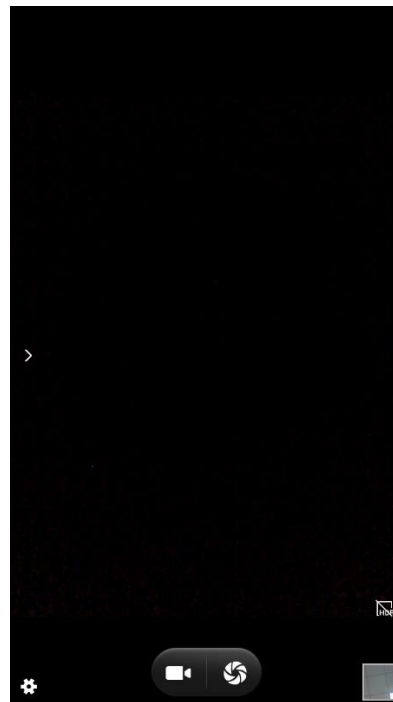

### 5.1.3 Viewing pictures

1. After taking a photo, a thumbnail of the picture is shown on the corner of the capture screen. Tap the thumbnail to view it.
2. Tap the onscreen button:



to share a photo.



to share through Bluetooth



to edit the photo



For more Camera options such as Delete, Edit, Rotate, Crop or photo details.

3. Swipe right or left to view more photos.

### **5.1.4 Shooting videos**

1. Tap the  to start recording video.
1. The countdown time remaining to shoot is located on the upper left; when the time left is less than a minute, the countdown turns red.
2. Point the lens to record the scene where you want to start.

Tap the  icon again to stop shooting.

The time remaining to shoot counts down at the left; when less than a minute is left, the countdown turns red.

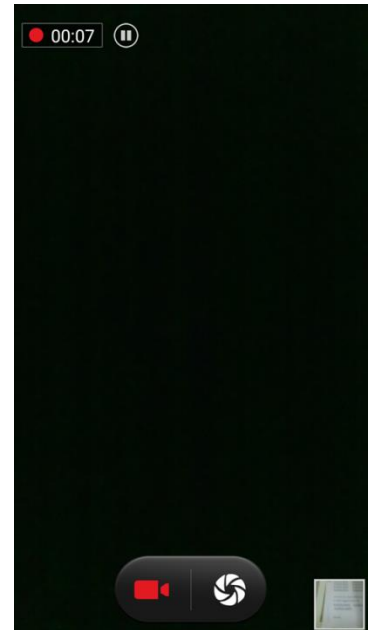

## **5.2 The Gallery**

1. Tap the launcher and then tap Gallery .
2. Tap a folder to view the pictures or video inside in full screen mode.
3. Flick the pictures left or right to view the previous or next picture.

## **Chapter 6: Using Barcode Reader**

This chapter explains how to use Barcode Reader and Android Winmate® Data Collection application.



## 6.1 Using Barcode Reader



### 6.1.1 Barcode Reader Location

2D Barcode Reader is an optional feature for Winmate® M700DM8 and may not be present in your device. Barcode Reader is located on the top side of the tablet.

### 6.1.2 Android Winmate® Data Collection (WDC)

The M700DM8 with Barcode Reader comes with pre-installed software made by Winmate® - Winmate Data Collection (WDC) that allows users to turn on the readers and set up the button to trigger the scan function.

### 6.1.3 Where to Find WDC

1. Tap application menu .
2. User can find the application **Data Capture (WDC)** on the menu screen, with the Globe mark  .
3. User can change the settings of the Barcode Reader through WDC application.

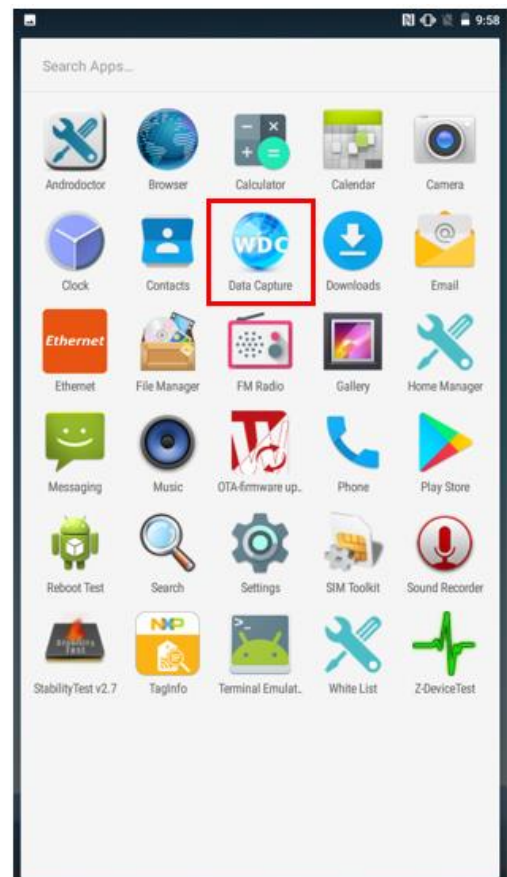

### 6.1.4 How to Turn On/Off the Power of Barcode Reader

1. Go to the **WDC** application.
2. Tap **Barcode Setting**  .

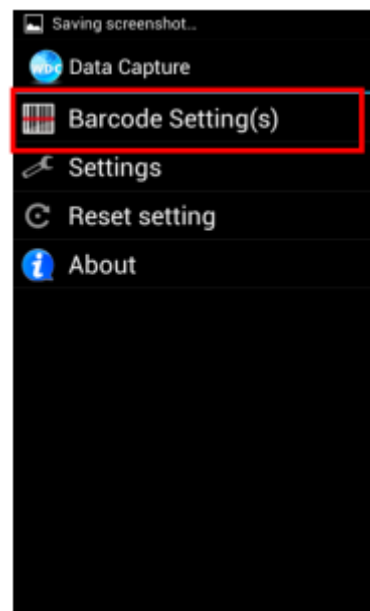

3. Once the user entered the WDC application, the device will automatically turn on the Barcode Reader. And the user can turn off the Barcode Reader by tapping **Barcode Power Status: ON**.

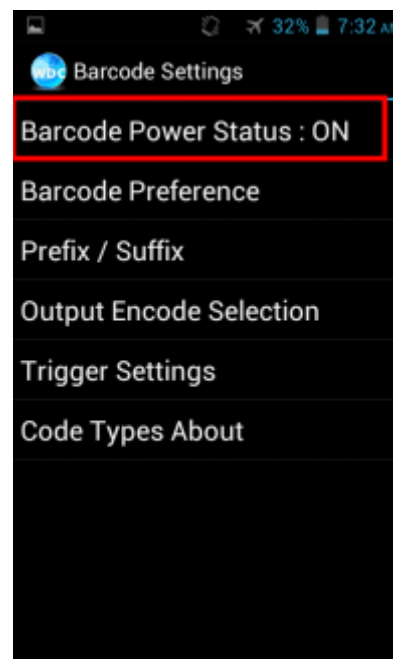

### 6.1.5 How to Change the Symbologies of Barcode

1. Go to the **WDC application**.
2. Tap **Barcode Settings** .
3. Tap **Barcode Preference**.
4. Users can change the symbologies of the barcode:
  - 2D Symbologies
  - Imager Options
  - User Preference
  - Disable all symbologies.

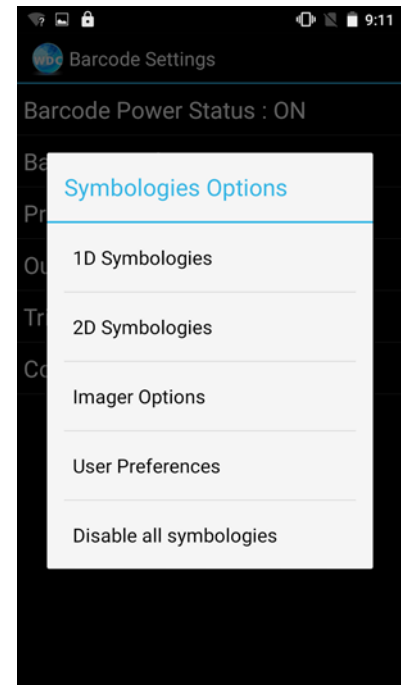

### 6.1.6 How to Add Command to the Barcode Output

1. Go to the **WDC application**.
2. Tap **Prefix / Suffix**.
3. Enter special characters at the beginning (prefix) or end (suffix) of the scanned barcodes.
4. Tap **Set** to add into the data.

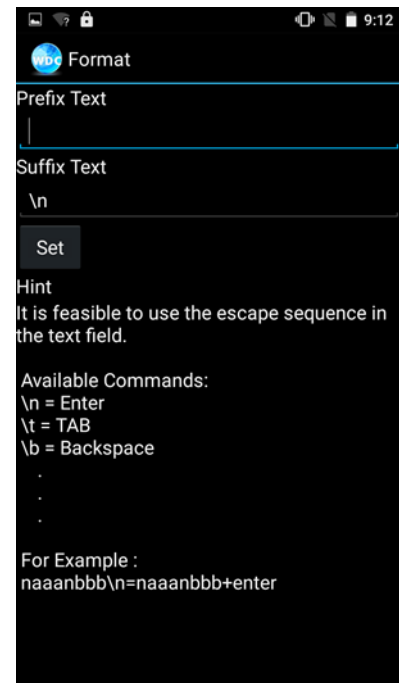

The output will show the command that you entered in the prefix or the suffix;

**For example**, if user enters “\n” in the **prefix text**, the output of the barcode reader will appear on the next line of the page. And if the user enters “\n” in the **suffix**, the **output of the barcode reader** will show the barcode and change to the start of the next line for the user. Same with the command “\t” and “\b”.

## 6.1.7 How to Change the Scan Type of the Barcode Reader

1. Go to the “WDC” application.
2. Go to **Barcode Settings** , tap **Trigger Settings**.
3. Select the **Scan Type** or select read time of the Barcode Reader.

To start scanning the barcode user has to leave the WDC application.

- **Auto Scan** – Barcode Reader starts auto-scanning once the user leaves the WDC application.
- **Multiple Scan** –After pressing the trigger button Barcode Reader starts continuously scanning and reading **multiple codes** within the time duration specified in **Read time option**.
- **Continuing Scan (default)** – After pressing the trigger button Barcode Reader can scan and read only a **single code** within the time duration specified in **Read time option**.

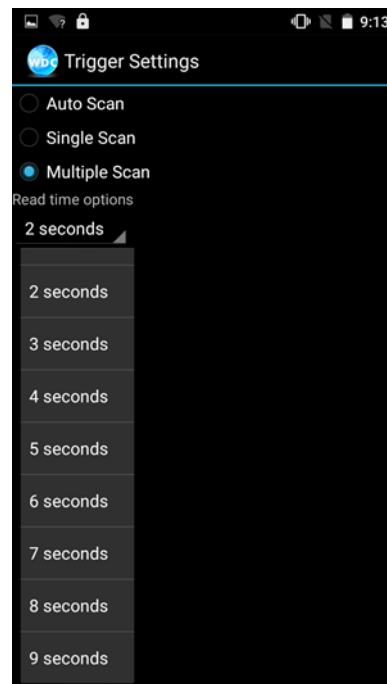

## 6.1.8 How to Change WDC Settings or Reset to Default

1. Go to the **WDC** application.
2. Tap **Settings**.
3. Users can select the options to change the setting of the application.
4. Users can reset to the default setting by tapping **Reset setting**.

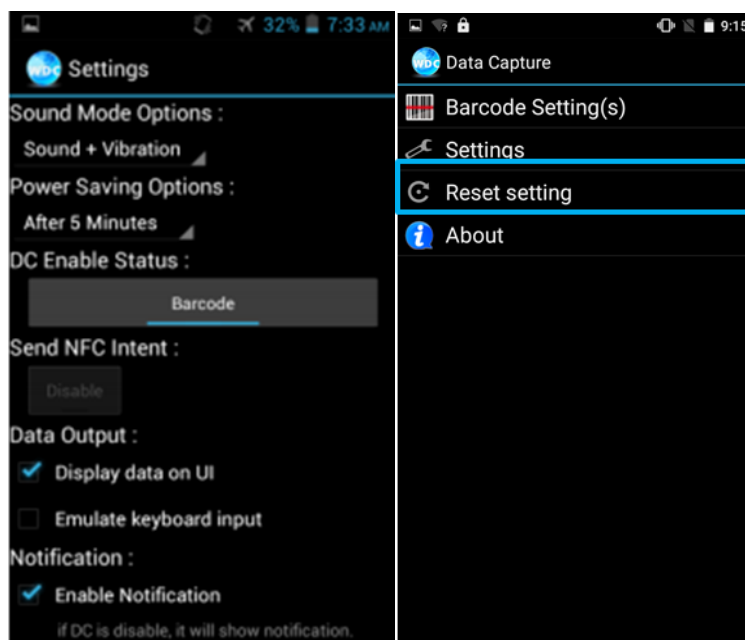



### 6.1.9 Scanning a Barcode

#### How to scan a barcode:

1. Press the function button to trigger the barcode.
2. Aim the barcode.
3. Ensure the entire barcode is within the rectangular area formed by the brackets in the laser framing.

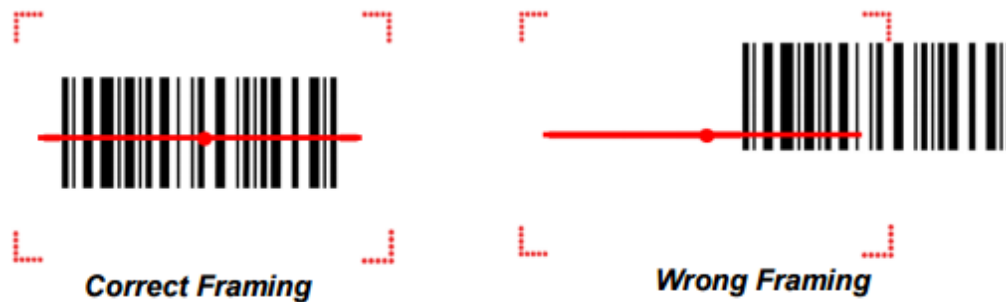

4. Release the trigger.

### 6.1.10 Scanning Tips and Considerations

#### Distance

Scanning device will decode perfectly over a certain working range, there are minimum and maximum distance from the barcode. To specify the appropriate working range per barcode type is through a table as follows.

| Symbology      | Density  | Min Distance | Max Distance |
|----------------|----------|--------------|--------------|
| Code 39        | 0.100 mm | 9.5 cm       | 11.5 cm      |
|                | 0.125 mm | 8.0 cm       | 14.5 cm      |
|                | 0.500 mm | 6.5 cm       | 50 cm        |
|                | 1.000 mm | 9.5 cm       | 75 cm        |
| EAN / UPS 100% | 0.33 mm  | 6 cm         | 34 cm        |
| DataMatrix     | 0.18 mm  | 7.5 cm       | 16.5 cm      |
|                | 0.25 mm  | 6.0 cm       | 23.0 cm      |
|                | 0.38 mm  | 5.5 cm       | 34.5 cm      |
| PDF417         | 0.25 mm  | 5.5 cm       | 26 cm        |
|                | 0.38 mm  | 6.5 cm       | 37 cm        |

#### Angle

Scanning angle is important for promoting quick decodes.

|                |                  |       |
|----------------|------------------|-------|
| Scanning Angle | Horizontal 34.4° | 34.4° |
|                | Vertical         | 22.2° |
| Framing Angle  | Horizontal       | 30°   |
|                | Vertical         | 20°   |

## **Chapter 7: Accessories**

The M700DM8 accessories provide a variety of product support capabilities. Some of the accessories are optional and are not included to standard packaging list.

---

## 7.1 Standard Accessories

M700DM8 Standard Accessory List:

- **\*Universal USB Adapter**  
Input: AC 100-240V  
Output: 5V 3A for M700DM8
- **Battery**  
Part Number: 98K007SP002P

*\*Universal USB Adapter socket varies by country and region. M700DM8 will be shipped with the socket according to your order.*

## 7.2 Optional Accessories

M700DM8 Optional Accessory List:

- **Battery Charging Dock**  
Part Number: 98TA00Z00003
- **Vehicle Dock (Charging + Connections)**  
Part Number: 98TA07Z00004
- **Vehicle Dock (Charging Only)**  
Part Number: 98TA07Z00003
- **Desk Dock**  
Part Number: 98TA07Z00005
- **Hand Strap**  
Part Number: 98K000A0004R
- **Carry Bag**  
Part Number: 9B000000000X
- **Micro SD Card**  
Part Number: 76G004300000
- **Capacitive Touch Stylus**  
Part Number: 9B000000001D
- **Mobile Printer MX20**  
Part Number: 9B000000007B
- **Mobile Printer MX30**  
Part Number: 9B000000007A
- **Vehicle Adapter**  
Part Number: 98TZ00ZZ0006

## **Appendix**

Appendix includes additional product information, including technical specifications; order information, OS image and OTA update procedures.

---

## Appendix A: Product Specifications

|   |                        | Model Name  |
|---|------------------------|---|
|   |                        | M700DM8   |
| <b>Display Specification</b>                          | Size                   | 7"  |
|   | Resolution             | 1280 x 720  |
|   | Brightness             | 650 nit (typ.)  |
|   | Touch                  | Projected Capacitive Touch  |
| <b>System Specification</b>                           | Processor              | ARM® Cortex™-A53 Octa-Core, 1.3GHz  |
|   | System Memory          | 2GB SDRAM LDDR3   |
|   | Storage                | 16GB eMMC   |
|   | OS                     | Android 7.0 Nougat  |
| <b>Wireless Communications</b>                        | WLAN                   | Support 802.11 a/b/g/n mode   |
|   | Bluetooth              | Bluetooth 4.0   |
|   | GNSS                   | Built-in GPS module, supports GLONASS   |
|   | WWAN                   | WCDMA/LTE   |
| <b>System I/O Buttons Indicators Sensors Security</b> | Internal Audio         | 1 x 1.2W Speaker  |
|   | External I/O           | 1 x Micro USB OTG<br>1 x Headset jack (Mic+Earphone)<br>1 x 2.5Ø 5V DC Power Input<br>1 x SIM Slot<br>2 x Microphones<br>1 x Micro SD Card Slot |
|   | Buttons                | 1 x Volume - +<br>1 x Power button<br>4 x Front Key   |
|   | LED Indicators         | 1 x LED indicator   |
|   | Sensors                | Light Sensor, G-sensor, Proximity Sensor  |
|   | Camera                 | Rear: 8MP Camera with LED auxiliary light (Auto Focus)<br>Front: 2 MP Camera (Either one with Barcode Reader)                                   |
| <b>Data Capture</b>                                   | Data Capture           | NFC (Read / Write, Peer to Peer mode)<br>2D Barcode Reader (Optional)   |
|   |                        |   |
| <b>Mechanical and Environment</b>                     | Operating Temp.        | -20°C ~ +60°C (AC Mode)<br>-10°C ~ +50°C (Battery Mode)   |
|   | IP Proof               | IP65  |
|   | Vibration              | MIL-STD-810G Method 514.6 Procedure I   |
|   | Drop                   | MIL-STD-810G Method 516.6, 4 ft, Free to concrete   |
|   | Certifications         | CE, FCC   |
|   | Dimensions (W x L x H) | 212.4 x 132.8 x 19 mm   |
|   | Weight                 | 550g  |
| <b>Power Management</b>                               | Battery                | 3.7V 5300mAh Li-Poly user hot-swappable battery   |
|   | Battery Operating Time | 12Hr* based on the full-loading   |
|   | Adapter                | 5V 2A Adapter   |

\* Note: measured at dimming LCD brightness. Varies depending on the usage conditions, or when an external device is attached.

\*\*Note: all specifications are subject to change without prior notice.

## Appendix B: Order Information

M700DM8 Series available in the following configurations:

| Model Number  | Specifications                         |
|---------------|--|
| M700DM8-4E    | Standard                               |
| M700DM8-4EH   | Standard with hotswap battery          |
| M700DM8-4EBM  | 2D Barcode Reader                      |
| M700DM8-4EBMH | 2D Barcode Reader with hotswap battery |

## Appendix C: Software Development Kit

Winmate® provides the following drivers and SDK for M700DM8. Download SDK from Winmate Download Center.

| Item | File Type          | Description   |
|------|--------------------|---|
| 1    | M700DM8 Drivers    | Android Debug Bridge(ADB) Driver / USB Driver                             |
| 2    | M700DM8 Flash Tool | Flash Tool  |
| 3    | General SDK (WDC)  | Development kit for WDC, including Barcode Reader and Fingerprint Scanner |

**Winmate Download Center:**

<http://www.winmate.com> > Support > Download Center > Industrial tablet> M700DM8 > Development Kit / Drivers

Or click [here](#)

## Appendix D: OS Image Update

Winmate provide OS Image update tool. Refer to “OS Image Update Tool Guide” for a detailed instruction on how to update OS image.

Download OS Image update tool and OS Image Update Tool Guide from [Winmate Download Center](#).

## Appendix E: OTA Online Update

You can use online OTA Update tool to update firmware version.



### Important

Battery capacity must not be lower than 30% during update.

To update OTA:

1. Select **OTA-firmware**.
2. Select **Manual check**.
3. Check "I agree to update" and click "**UPDATE**".

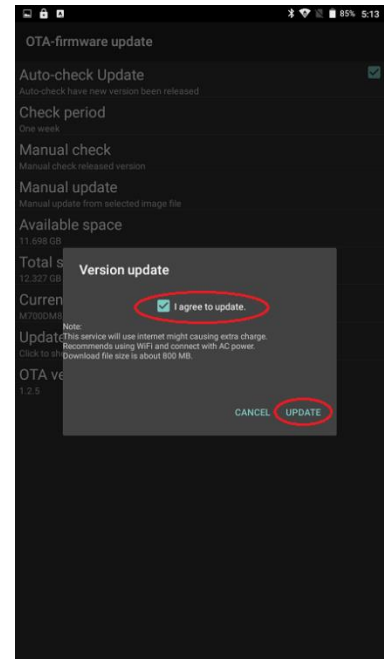
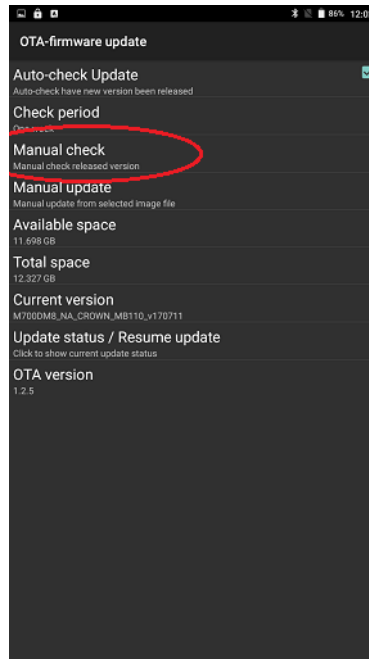
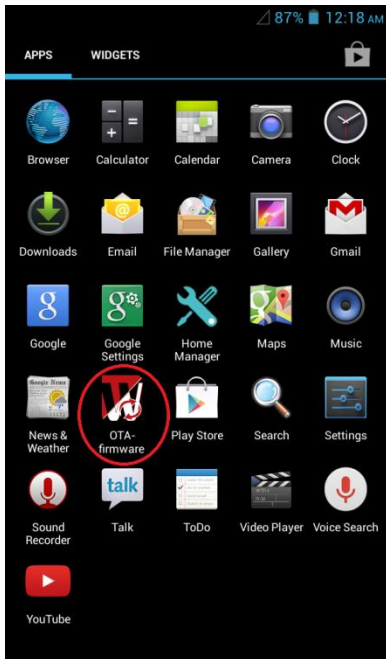

4. Wait for download finish it will take some time.
5. Click "**REBOOT NOW**".
6. Wait while Ota is updating.

