

M900P Series

8-inch Rugged Windows Tablet

Intel® Apollo Lake Pentium N4200

Windows® 10 IoT Enterprise



Quick Start Guide

Contents

CHAPTER 1: READ ME FIRST	3
1.1 ADVISORY CONVENTIONS	3
1.2 SAFETY INFORMATION	4
1.3 HANDLING AND MAINTENANCE	6
1.4 DECLARATION OF CONFORMITY (DOC)	7
CHAPTER 2: GETTING STARTED	8
2.1 INTRODUCTION	8
2.2 UNPACKING	8
2.3 DESCRIPTION OF PARTS	9
2.4 HOTKEY FOR SPECIFIC FUNCTIONS	10
2.5 FIRST-TIME OPERATION	11
2.5.1 <i>Installing SIM Card (For 4G/LTE Equipped Devices)</i>	11
2.5.2 <i>Installing Battery</i>	11
2.5.3 <i>Charging Your Tablet</i>	12
2.5.4 <i>Starting the Tablet</i>	12
CHAPTER 3: OPERATING THE DEVICE	13
3.1 HOTTAB INTRODUCTION	13
3.1.1 <i>Using the Physical Function Keys (Hotkeys)</i>	14
3.1.2 <i>Adjusting Brightness and Volume</i>	15
3.2 CHANGING TOUCHSCREEN MODES	16
3.2.1 <i>Switch via Built-in HotTab Utility</i>	16
3.2.2 <i>Switch via Programmable Function Buttons</i>	17
3.3 USING CAMERA	18
3.4 USING WIRELESS COMMUNICATIONS	19
3.5 USING BARCODE READER	19
3.6 USING HF RFID READER	20
3.7 USING MSR/ EMV CARD READER	21
APPENDIX	23
APPENDIX A: PRODUCT SPECIFICATIONS	23

Chapter 1: Read Me First

1.1 Advisory Conventions

Four types of advisories are used throughout the user manual to provide helpful information or to alert you to the potential for hardware damage or personal injury. These are Notes, Important, Cautions, and Warnings. The following is an example of each type of advisory.



Note:

A note is used to emphasize helpful information



Important:

An important note indicates information that is important for you to know.



Caution! Attention

A Caution alert indicates potential damage to hardware and explains how to avoid the potential problem.

Une alerte d'attention indique un dommage possible à l'équipement et explique comment éviter le problème potentiel.



Warning! Avertissement!

An Electrical Shock Warning indicates the potential harm from electrical hazards and how to avoid the potential problem.

Un Avertissement de Choc Électrique indique le potentiel de chocs sur des emplacements électriques et comment éviter ces problèmes.

1.2 Safety Information



Precaution on Battery Pack **Précaution avec le bloc-pile**

Do Not Disassemble, Modify, or Insert Sharp Objects Into the Battery Pack. Electrolyte leakage, generation of heat, ignition or rupture may result.

[FR] Ne pas démonter, modifier, ou insérer des objets pointus à l'intérieur du bloc-pile. Une fuite d'électrolyte, la génération de chaleur, l'amorçage ou la rupture peuvent être occasionnés.

Do Not Short the Positive (+) and Negative (-) Terminals of the Battery. Generation of heat, ignition or rupture may result. When carrying or storing the device, do not place the battery pack together with articles that may contact electricity.

[FR] Ne pas court-circuiter les bornes Positive (+) et Négative (-) de la pile, la génération de chaleur, l'amorçage ou la rupture peuvent être occasionnés. Lors du transport et du rangement de l'appareil, ne pas placer le bloc-pile en même temps que des articles pouvant créer un contact électrique.

Do Not Apply Shocks to the Battery by Dropping It or Applying Strong Pressure to It. Electrolyte leakage, generation of heat, ignition or rupture of battery may occurs.

[FR] Ne pas faire subir de choc à la pile en la laissant tomber ou en appliquant une forte pression dessus. Une fuite d'électrolyte, la génération de chaleur, l'amorçage ou la rupture peuvent être occasionnés.

Do Not Charge the Battery Other Than Methods Those Specified In This Manual. If the battery is not charged using one of the specified methods, electrolyte leakage, generation of heat, ignition or rupture may result.

[FR] Ne pas charger la pile par d'autres méthodes que celles spécifiées dans ce manuel. Si la pile n'est pas chargée en utilisant l'une des méthodes spécifiées, une fuite d'électrolyte, la génération de chaleur, l'amorçage ou la rupture peuvent être occasionnés.

When the Battery Pack Has Deteriorated, Replace It with a New Battery. Continued use of a damaged battery pack may result in heat generation, ignition or battery rupture.

[FR] Lorsque la pile est détériorée, la remplacer par une nouvelle pile. L'utilisation continue d'une pile endommagée peut occasionner une génération de chaleur, l'amorçage ou la rupture de la pile.

Do Not Expose the Battery Pack to Excessive Heat, or Extreme Heat (Near Fire, in Direct Sunlight for example) Generation of heat, ignition or rupture may result

[FR] Ne pas exposer le bloc-pile à une Chaleur Excessive, ou une Chaleur Extrême (Près d'un feu, sous la lumière du soleil par exemple) Une production de chaleur, l'amorçage ou la rupture peuvent être occasionnés

Do Not Use the Battery Pack With Any Other Products. The battery pack is rechargeable and is only designed for this specific product. If it is used with a product other than the specified product, electrolyte leakage, generation of heat, ignition or rupture may result.

[FR] Ne pas utiliser avec un autre produit La batterie est rechargeable et a été conçue pour un produit spécifique. Si elle est utilisée sur un produit différent de celui pour lequel elle a été conçue, des pertes d'électrolytes et une production de chaleur sont possibles, elle risque également de prendre feu ou de casser.

Do Not Use This Product With Battery Other Than the One Specified.

[FR] Ne pas utiliser ce produit avec une batterie autre que celle spécifiée

Discontinue using device immediately if you notice the battery is swelling, or looks puffy or misshapen. Do not attempt to charge or use the device. Do not handle a damaged or leaking battery. Do not let leaking battery fluid come into contact with your eyes, skin or clothing.

[FR] Si vous remarquez une pile gonflée, élargie ou anormale, cesser l'utilisation de l'appareil immédiatement. N'essayez pas de recharger l'appareil ou de l'utiliser. Ne pas manipuler une pile qui fuit ou qui est endommagée. Ne laissez pas de liquide qui fuit entrer en contact avec vos yeux, votre peau ou vos vêtements.



General Product Safety **Sécurité générale des produits**

- Do not block any ventilation openings. Do not place the product against a wall or in an enclosed space as doing so might impede the flow of cooling air.
- *[FR] Ne pas bloquer les ouvertures de ventilation. Ne pas placer le produit contre un mur ou dans un espace clos de façon à entraver la circulation de l'air de refroidissement.*
- Do not place the product near any heat sources such as radiators, warm air intakes, stoves or other heat-generating devices (including amplifiers or other heat producing equipment).
- *[FR] Ne pas placer le produit près d'une source de chaleur comme des radiateurs, les arrivées d'air chaud, poêles ou autres produits générant de la chaleur (y compris les amplificateurs ou autre équipement produisant de la chaleur.)*
- Protect the power cord from being crushed or pinched, particularly in the area of the plugs, any receptacles used, and the point of exit from the apparatus. Do not break off the ground pin of the power cord.
- *[FR] Empêcher le cordon d'alimentation d'être écrasé ou pincé, en particulier dans les zones de prises, des containers utilisés, et du point de sortie de l'appareil. Ne pas casser la broche de terre du cordon d'alimentation.*
- Do not disregard the safety that a polarized or grounded connection can provide. A polarized connection consists of two plugs, one of which is larger than the other. A grounded connection has two blades and a third one that is grounded. If the main plug provided cannot be inserted into your outlet, consult an electrician to replace your obsolete outlet.
- *[FR] Ne pas ignorer la sécurité qu'une prise polarisée ou une prise de terre peut prévoir. Une prise polarisée se compose de deux fiches, dont l'une est plus large que l'autre. Une prise de terre possède deux lames et une troisième qui est la terre. Si la fiche principale fournie ne peut être insérée dans votre prise, consultez un électricien pour remplacer votre prise obsolète.*
- Use only accessories specified by the manufacturer.
- *[FR] Utiliser uniquement les accessoires spécifiés par le fabricant.*

- This product should not be used near water such as bathtubs, sinks, swimming pools, wet basement, etc.
- *[FR] Ce produit ne doit pas être utilisé près de l'eau comme les baignoires, les éviers, les piscines, les sous-sols humides, etc.*

- Use only with its transport carriage, stand, tripod, console or table specified by the manufacturer or sold with the product. When using a carriage, move the carriage assembly with the product carefully to avoid damage from falling over.
- *[FR] Utiliser uniquement avec son chariot de transport, support, trépied, console ou table spécifiés par le fabricant ou vendu avec le produit. Lors de l'utilisation d'un charriot, déplacez l'ensemble chariot avec le produit avec soin pour éviter tout dommage de chute.*

- Unplug this apparatus during lightning storms or when it is not being used for long periods.
- *[FR] Débrancher cet appareil durant les orages ou lorsqu'il n'est pas utilisé pendant de longues périodes.*

- Refer all servicing to qualified service personnel. A technical intervention is required when the apparatus has been damaged in any way, for example if the power cord or plug is damaged, liquid has been spilled or objects have fallen inside the unit, if the product has been exposed to rain or moisture, if it does not operate normally or if it has been dropped.
- *[FR] Confier toute réparation à du personnel qualifié. Une intervention technique est nécessaire lorsque l'appareil a été endommagé de quelque façon, par exemple si le cordon d'alimentation ou la fiche est endommagé, du liquide a été renversé ou des objets sont tombés à l'intérieur de l'unité, si le produit a été exposé à la pluie ou à l'humidité, s'il ne fonctionne pas normalement ou s'il a été jeté.*



General Guideline **Directive générale**

It is recommended to reboot the device when some functions are defect or inactive. If it still can't solve the problems please contact your dealer or agent.

Il est recommandé de redémarrer l'appareil lorsque certaines fonctions sont défectueuses ou inactives. Si le problème persiste, veuillez contacter votre revendeur ou votre agent.

1.3 Handling and Maintenance



General Guideline Guide Général

Keep the product at least 13 cm (5 inches) away from electrical appliances that can generate a strong magnetic field such as TV, refrigerator, motor, or a large audio speaker.

[FR] Garder le produit au moins à 13 cm (5 pouces) de distance des appareils électriques qui peuvent générer un fort champ magnétique comme une télévision, un réfrigérateur, un moteur, ou un important haut-parleur.

Do not place heavy objects on top of the tablet computer as this may damage the display.

[FR] Ne pas placer d'objets lourds sur le dessus de l'ordinateur tablette cela peut endommager l'écran.

The screen surface can be easily scratched. Use with care. Do not use paper towels to clean the display but use the included cleaning cloth. Avoid touching it with a pen or pencil.

[FR] La surface de l'écran peut être facilement rayée. Utiliser avec précaution. Ne pas utiliser de serviette en papier pour nettoyer l'écran mais utiliser le chiffon de nettoyage inclus. Éviter de toucher avec un stylo ou un crayon.

To maximize the life of the backlight in the display, allow backlight to automatically turn off as a result of power management. Avoid using a screen saver or other software that prevents the power management from working.

[FR] Pour maximiser la durée de vie du rétroéclairage de l'écran, autoriser le rétroéclairage résultant de la gestion de l'alimentation. Éviter d'utiliser un économiseur d'écran ou un autre logiciel empêchant la gestion de l'alimentation de fonctionner.



Cleaning Guideline Guide de nettoyage

Use a soft cloth moistened with water or a non-alkaline detergent to wipe the exterior of the product.

[FR] Utiliser un chiffon doux humidifié avec de l'eau ou un détergeant non alcalin pour essuyer l'extérieur du produit.

Gently wipe the display with a soft, lint-free cloth. Do not use alcohol or detergent on the product.

[FR] Essuyer délicatement l'écran avec un chiffon doux non pelucheux. Ne pas utiliser d'alcool ou un détergent sur le produit.



Touchscreen Guideline Guide de l'écran tactile

Use your finger or the stylus on the display. Using sharp or metallic object may cause scratches and damage the display, thereby causing errors.

[FR] Utiliser votre doigt ou le stylet sur l'écran. L'utilisation d'un objet pointu ou métallique peut provoquer des rayures.

Use a soft cloth to remove dirt on the display. The touchscreen surface has a special protective coating that prevents dirt from sticking to it. Not using a soft cloth may cause damage to the special protective coating on the touchscreen surface. To clean off hard to remove dirt, blow some steam on the particular area and gently wipe away using a soft cloth.

[FR] Utiliser un chiffon doux pour enlever la poussière sur l'écran. La surface de l'écran tactile a un revêtement protecteur spécial empêchant la saleté de se coller à lui. Ne pas utiliser un chiffon doux peut endommager le revêtement spécial sur la surface de l'écran tactile. Pour nettoyer les saletés plus difficiles à enlever, souffler de la buée sur la zone particulière et essuyer doucement avec un chiffon doux.

Do not use excessive force on the display. Avoid placing objects on top of the display as this may cause the glass to break.

[FR] Ne pas utiliser une force excessive sur l'écran. Éviter de placer des objets au dessus de l'écran cela pourrait provoquer une cassure du verre.

When there is a noticeable discrepancy in the operation of the touchscreen function (your touch does not correlate to the proper location on the screen), recalibrate the touchscreen display.

[FR] Lorsqu'il y a un écart sensible dans le fonctionnement de l'écran tactile (votre contact ne correspond pas à la bonne position sur l'écran), recalibrer l'écran tactile.

1.4 Declaration of Conformity (DoC)

FCC Statement

This device complies with part 15 FCC rules.



Operation is subject to the following two conditions:

- This device may not cause harmful interference.
- This device must accept any interference received including interference that may cause undesired operation

This equipment has been tested and found to comply with the limits for a class "B" digital device, pursuant to part 15 of the FCC rules. These limits are designed to provide reasonable protection against harmful interference when the equipment is operated in a commercial environment. This equipment generates, uses, and can radiate radio frequency energy and, if not installed and used in accordance with the instruction manual, may cause harmful interference to radio communications. Operation of this equipment in a residential area is likely to cause harmful interference in which case the user will be required to correct the interference at his own expense.

CE Notice (European Union)



Electromagnetic Compatibility Directive (2014/30/EU)

- EN55024: 2010/ A1: 2015
 - IEC61000-4-2: 2009
 - IEC61000-4-3: 2006+A1: 2007+A2: 2010
 - IEC61000-4-4: 2012
 - IEC61000-4-5: 2014
 - IEC61000-4-6: 2014
 - IEC61000-4-8: 2010
 - IEC61000-4-11: 2004
- EN55032: 2012/AC:2013
- EN61000-3-2:2014
- EN61000-3-3:2013

Low Voltage Directive (2014/35/EU)

- EN 60950-1:2006/A11:2009/A1:2010/A12:2011/ A2:2013

This equipment is in conformity with the requirement of the following EU legislations and harmonized standards. Product also complies with the Council directions.

Chapter 2: Getting Started

2.1 Introduction

Thank you for purchasing 8-inch Rugged Windows Tablet Computer M900P.

The M900P is a compact rugged tablet PC with robust set of features designed to withstand industrial use while providing high tech solutions that increase productivity, improve safety, and reduce operational costs. The processing power comes from Intel's Apollo Lake processor paired with genuine Intel graphics for high performance. The tablet features a brilliant projective capacitive touch screen, which is outdoor viewable and offers 1280 x 800 pixel resolution. Weighing at just 2.2 pounds (approx. 900 grams) the M900P delivers lightweight mobility in a rugged tablet.

Highlights

- 8" daylight readable panel with direct optical bonding
- Intel® Apollo Lake Pentium N4200 processor
- Default D-sub for vehicle gateway connection
- Optional EMV/MSR reader
- IP65 waterproof and dustproof

2.2 Unpacking

Check and identify the standard supplied accessories.

Standard factory shipment list:

- 8-inch Rugged Tablet M900P

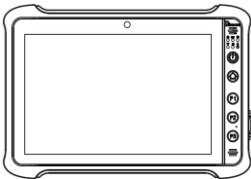

- Standard Battery



- Power Adapter



- Power Cord and Plugs



- Quick Start Guide & Driver CD

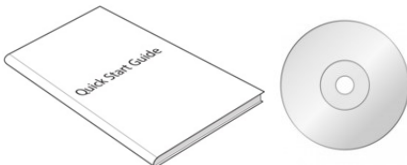



Your package may include other optional accessories based on your order.

- Desk Dock
- Vehicle Cradle
- Battery Charger
- Vehicle Gateway
- Carry Bag
- Hand-Strap

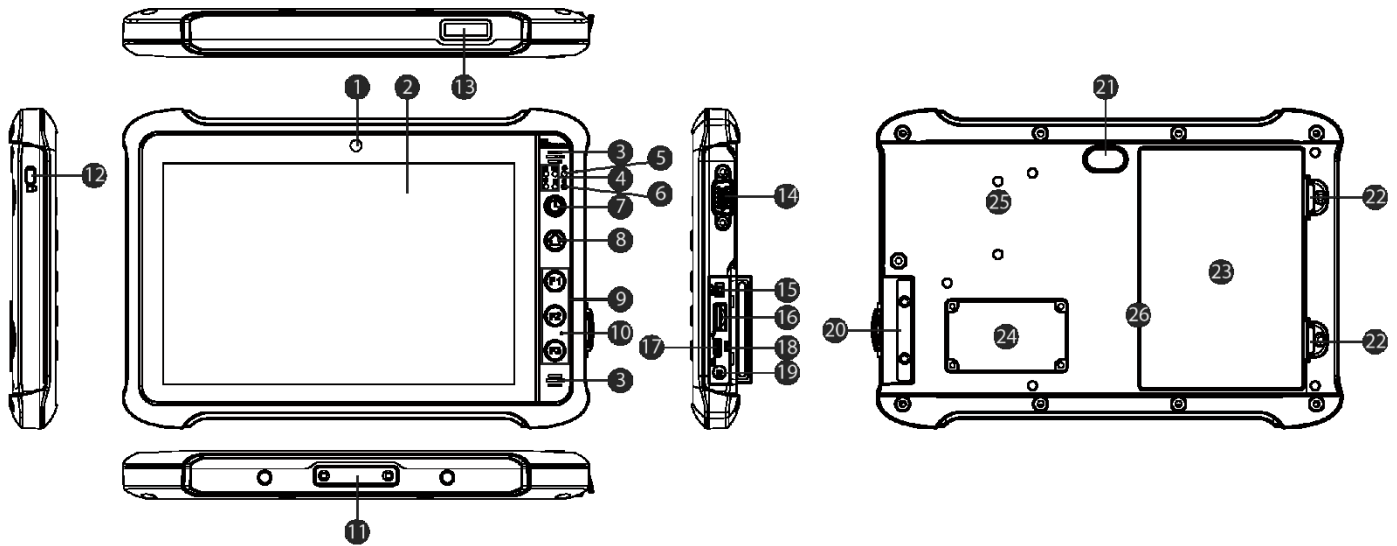
2.3 Description of Parts



No	Item	Description
1	Camera	2 MP Webcam.
2	8" Touch Screen	Display and act as one of the inputs for the rugged tablet.
3	Speaker	Two 1 Watt speakers for audio output.
4	LED Indicators	Show the current status of the Tablet: power, battery, wireless communications, and storage.
5	Light Sensor	 Light sensor helps to adjust display backlight.
6	Mic	 Use during video recordings and communications.
7	Power Button	Power on/off tablet.
8	Menu Button	Hottab quick access.
9	Function Buttons	Three programmable function key configured by Hottab Utility.
10	Mic	Use during video recordings and communications.
11	Optional Docking Connector	Port to docking solutions such as desk docking to provide power and external I/O.
12	Kensington Security Slot	Insert the lock into the Kensington slot on the tablet and secure the lock with its key or its combination.
13	Optional Barcode	Allows you to scan 1D/2D barcodes.

Front LED Indicator Details:

No	Item	Description
14	D-Sub Connector	To connect a Vehicle Gateway.
15	Mic In/Line Out	Connect headset or headphone (Mic is only supported with 3.5mm 4-pin headset).
16	USB 3.0 Type-A	USB 3.0 port connects to USB devices, such as USB flash drive, mouse, keyboard, printer, etc. 5V/0.9A.
17	Reset Button	Hardware reset button.
18	USB 3.0 Type-C	High speed USB port connects to USB devices, such as mouse, keyboard, printer, etc. Note: The USB Type-C connector follows USB 3.0 standard, which does not support Alternate Mode (ALT) or USB Power Delivery (USB-PD).
19	Power Jack	Power input 12V DC
20	I/O Cover	Protect I/O ports
21	Rear Camera	8MP camera with autofocus and LED light.
22	Battery Lock Latch	Latch to lock the battery in place once battery is inserted.
23	Battery	7.6V, typ. 4200 mAh Li Polymer Battery (2S2P).
24	4G/ LTE Module	Service window provides access to 4G / LTE Module.
25	Optional RFID	Allows you to read HF RFID tags.
26	Micro-SIM card & Micro SD card slot.	Slot for Micro SIM card & Micro SD insert. (Behind the Battery)

2.4 Hotkey for Specific Functions

For the physical buttons on the tablet computer, in addition to its dedicated functions detailed in the previous section, it can also be used to emulate commonly used keyboard key strokes. Under different scenario, a single physical button or a combination of physical buttons provide different keyboard key strokes, which are specified below:

In POST (Before Windows boots up):

Button	Keystroke
Fn1	F6 to enter Recovery Menu
Fn2	F7 to enter BIOS setup screen
Fn3	Keyboard F3
Menu + Fn1	Enter





In Windows:

Button	Keystroke
Menu	Hottab Quick Access
Fn1	Default: Web Browser/ Increase (Note 1).
Fn2	Default: Camera/ Decrease (Note 1)
Fn3	Default: Notepad, or Barcode trigger (Note 2).
Power	Power ON/ OFF

Note 1: Fn1/ Fn2 can be use to increase/ decrease level when Brightness or Volume bar appears.

Note 2: Fn3 is trigger button when connected with barcode scanner.

LED Indicators Description:

Indicator	Icon	Description
Power Indicator		Blue – Tablet is on. No light – Tablet is off.
Battery Status		Orange –AC adapter is plugged in and charging. Green –AC adapter is plugged in and battery is full charged. Solid Red - Low battery (<10%). Blinking Red – Battery is being hot swapped. No light – Battery is in use and more than 10%.
Disk Activity Indicator		Green - Disk is active. No light - Disk is idle.
RF Communications		Green – Wi-Fi/BT/WWAN/GPS is on. No light – Wi-Fi/BT/WWAN/GPS are all Off.

2.5 First-Time Operation

To get started:

1. Install SIM card (If your device is equipped with 4G/LTE).
2. Install storage card.
3. Install the battery.
4. Charge your tablet.
5. Start the tablet.

2.5.1 Installing SIM Card (For 4G/LTE Equipped Devices)

The Tablet Computer supports 4G/LTE data connection and fits a Micro-SIM card.



Caution

Power off the tablet before installing the 4G/LTE module and Micro SIM card, or the tablet computer might be damaged by the incorrect installation behaviors.

To install the SIM card:

1. Remove the battery.
2. The SIM card slot is located right next the battery connector.
3. Install SIM card into slot with IC facing down the contact patch.

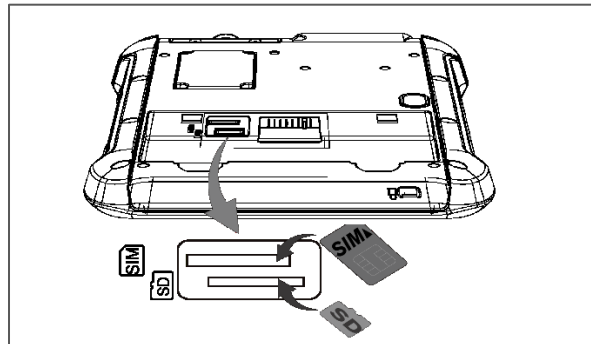
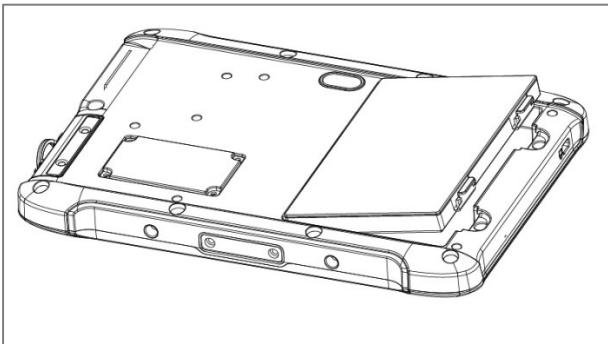

2.5.2 Installing Battery

To install the battery pack:

1. Disconnect any cords connected to the tablet computer.
2. Turn the tablet over, back facing up.
3. Insert the battery on the connector-pins side first, and then lower the battery into the battery compartment. Continue to hold the latches before battery is fully inserted.
4. Make sure the battery is completely lowered into the compartment before letting go the latches. Battery will be flat against the housing once fully inserted.

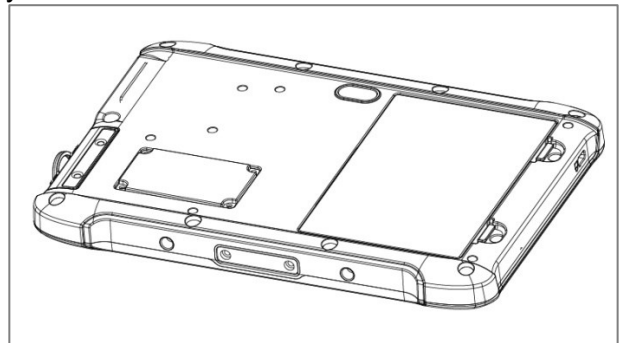
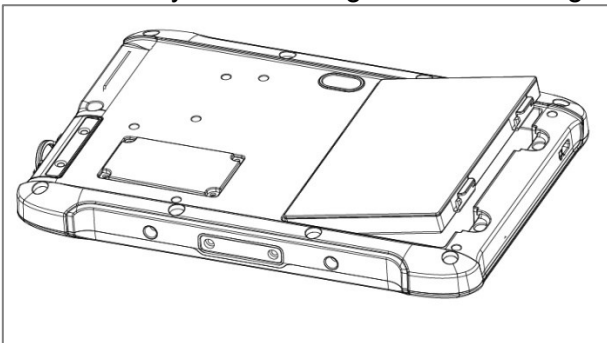

To remove the battery pack:

1. Shut down the tablet. Disconnect any cords connected to the computer.
2. Turn the tablet computer over, back facing up.
3. Hold the latches and lift the battery up to remove the battery.

2.5.3 Charging Your Tablet

The tablet operates either on external AC power or internal battery power. It is recommended to use AC power when you start up the Tablet for the first time.



Caution: Use only the AC adapter included with your Tablet Computer. Using other AC adapters may damage the Tablet Computer and the Battery.

To connect a tablet to AC power:

1. Open I/O protective cover by pulling out the latch.
2. Plug the DC cord of the AC adapter into the power jack of the tablet computer.
3. Plug the AC power cord into the AC adapter.
4. Plug the AC power cord into the electrical outlet.

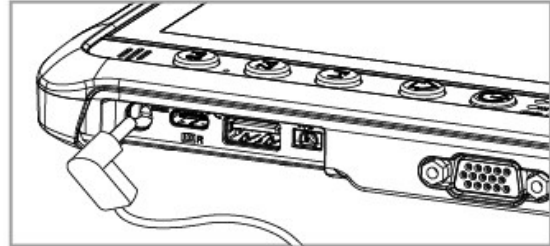
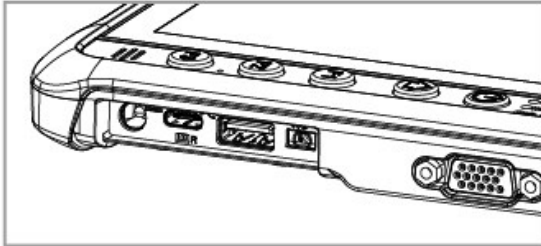

The battery LED indicator shows different battery states:

Orange - AC adapter is plugged in and battery is charging.

Green - AC adapter is plugged in and battery is fully charged.

Solid Red - Low battery level (<10%).

Blinking Red - Battery is being hot swapped.

No light - Battery is in use and charged (>10%).

Item	Battery Operation Time	Battery Charging Time
Standard Battery	6~7 Hours	2.5 Hours

2.5.4 Starting the Tablet



Important: When powering on the device for the first time, please make sure there's no interruption during the Windows setting up process, for example, accidentally powering off. If it happened, please access the recovery menu by pressing **Fn1** button on the front bezel to initiate recovery process.

Press and hold the power button for **3 seconds** until the blue LED power indicator light up.



Note: Do not press the power button repeatedly.

Do not perform the following operations until the Disk Activity Indicator off

- Connecting or disconnecting the AC adapter
- Pressing the power button
- Touching the tablet buttons, screen, or external keyboard/mouse

To power off the Tablet Computer:

1. Make sure you have closed any programs that are open on the Desktop. Start Screen apps don't need to be closed.
2. Tap on the **Settings** charm.
3. Tap on **Power**.
4. Tap on **Shut Down**.
5. Wait for Tablet Computer to power off.



Note: The computer will forcibly be powered off if the power button is pressed and held for **6 seconds or longer**.

Chapter 3: Operating the Device



3.1 Hottab Introduction

Hottab provides quick access to the tablet's functions and features, such as setting up shortcuts, using camera, powering on/off built-in devices, programming function key, and changing power management.







Note:

Please download the SDK from Winmate Download Center or check the Driver CD which is shipped with the tablet. Please notice that HF RFID reader, Barcode reader, MSR & Contact EMV reader are optional module, make sure user have ordered the module before using the SDK.

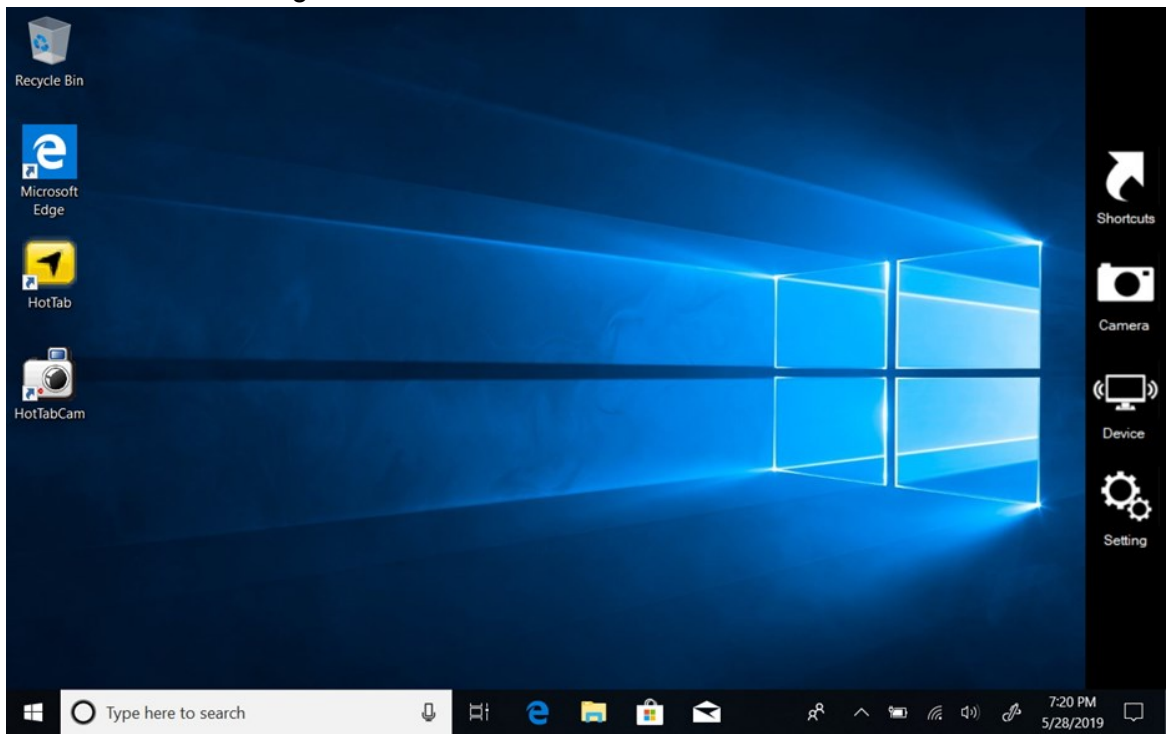
When Windows starts up, Hottab runs in the background. To display the Hottab control utility, press the  (Menu) button located on the front panel or launch the Hottab Utility application .

The main user interface is located on the right side of the screen. There are 4 main menu options: Shortcuts, Camera, Device ON/OFF, and Settings. Operations and functions on each menu options is explained in detail in the coming section.



Icon	Description
 Shortcuts	Allows users to configure short cut to quickly access programs with a few tabs.
 Camera	Allows users take a picture or record a video. User can also adjust setting related to camera in this menu option.
 Device ON/OFF	Enables/disables tablet computer's hardware functions. The configurable functions are Wi-Fi, WWAN (3G/4G/LTE), GPS, Bluetooth, Camera, LED indicators, Barcode Reader, RFID Reader, Touch set and GPS Antenna routing options.
 Settings	Provides users information such as PC Information, Battery status, and also device settings such as power management setting, function key mappings, and Brightness & Volume adjustment.

3.1.1 Using the Physical Function Keys (Hotkeys)



The function key mapping menu option allows user to change the physical function buttons, Fn1, Fn2 and Fn3. Users can change what application will be launched with short press or long press of keys.

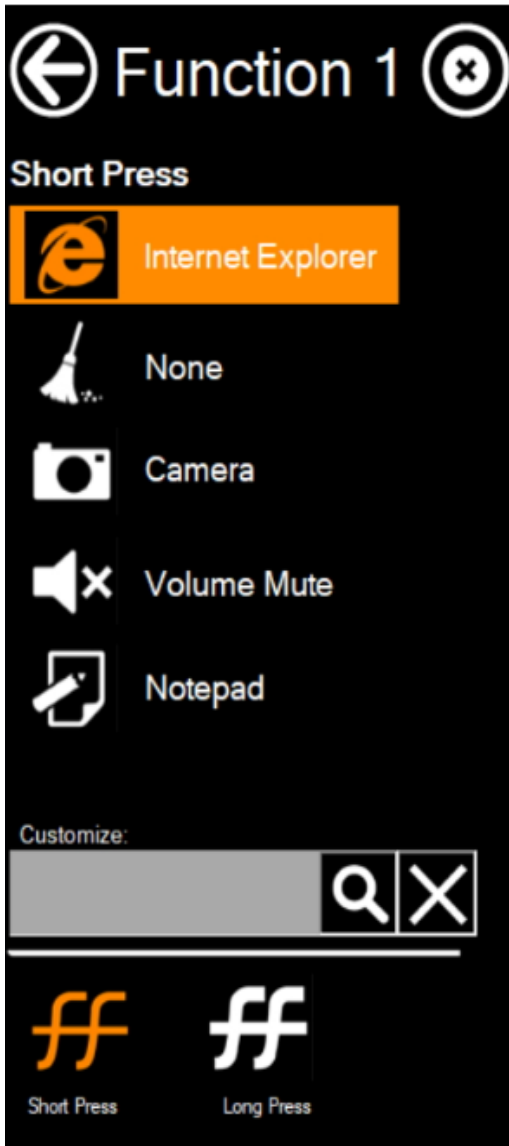



To configure function key mapping, perform the following:

1. Open the Hottab utility by press the  (Menu) Button located on the front panel, OR launching the Hottab Utility application.
2. Tap on the **Setting** button.
3. Tap on function key icon for the corresponding key that you want to change.
4. At top of utility, it will say “Short Press” or “Long Press” to indicate what type of press is being configured
5. You can switch what type of press you want to configure by tapping on the “Short Press” or “Long Press” icon at the bottom of the utility window.
6. Pick from list of preset applications by tapping on the application icons OR customize which application to execute using the picker.

Using the Custom picker:

1. Tap the  icon to reveal browser window
2. Navigate to the desired executable to map to function key
3. Tap on “Done” to save selection.

To map the function key to another application:

1. Tap on the  icon to remove connection to the original application, and pick again tapping on  icon.

Using the physical function keys:

1. While operating the tablet, click on the physical function keys to activate functions mapped via the setup in this section.

3.1.2 Adjusting Brightness and Volume

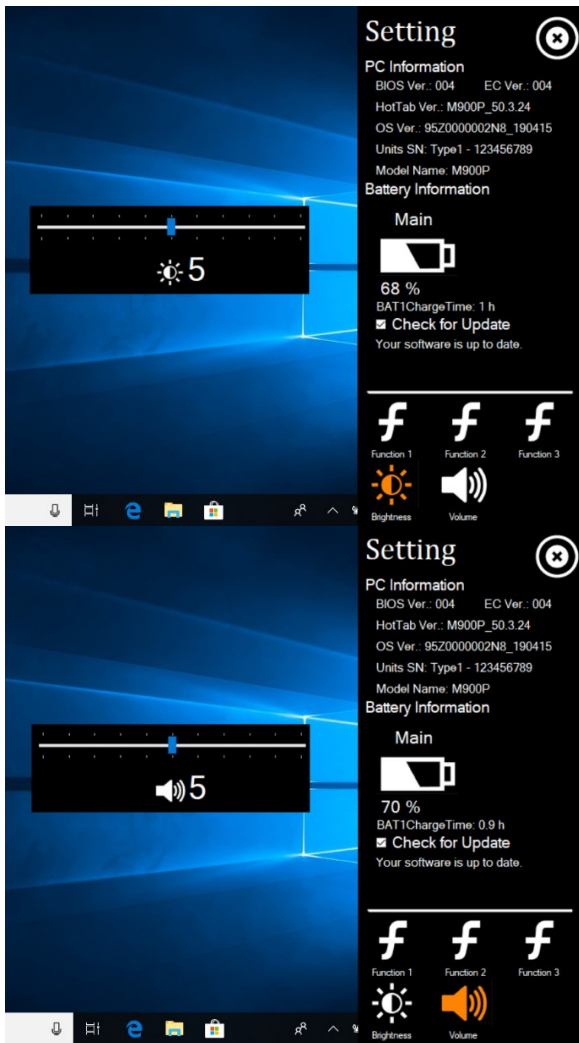

Brightness adjustment bar appear by clicking Brightness icon.



When the Brightness adjustment bar appeared, you can change the brightness level (0 ~ 10) by touch the bar on the screen or push F1 button to increase/ F2 to decrease brightness level.

Volume adjustment bar appear by clicking Volume icon.

When the Volume adjustment bar appeared, you can change the Volume level (0 ~ 10) by touch the bar on the screen or push F1 button to increase/ F2 to decrease Volume level.

3.2 Changing Touchscreen Modes

The tablet computer supports three built-in operating modes for different usage scenarios:

Mode	Usage Scenario
 <p>Hand/Rain (Default)</p>	<p>In <i>Hand/Rain</i> mode the touchscreen rejects false inputs from liquid drops. When the liquid is removed, the touchscreen accepts touch inputs from bare fingertips.</p> <p>Supports input by:</p> <ul style="list-style-type: none"> • Active stylus with palm rejection • Rubber tip passive stylus • Bare fingertips
 <p>Stylus</p>	<p>In <i>Stylus</i> mode, the touchscreen supports inputs from the fine-tip passive capacitive stylus (shipped with tablet).</p> <p>Support input by:</p> <ul style="list-style-type: none"> • Fine-tip passive stylus with palm rejection • Active stylus with palm rejection • Rubber tip passive stylus • Bare fingertips
 <p>Glove</p>	<p>In <i>Glove</i> mode, the touchscreen supports inputs while the user is operating the touchscreen with gloves on.</p> <p>Supports input by:</p> <ul style="list-style-type: none"> • Glove • Rubber tip passive stylus • Bare fingertips

To change touch mode:

- (1) Shortly press Function Key 1 (To define the function key refer to User Manual, Chapter 4).
- (2) Press  (Menu) button on the front to open HotTab, or launch HotTab Utility application.

Choose “**Device ON/OFF**”, and then click “**Touch Set**” icon. 

3.2.1 Switch via Built-in HotTab Utility

To switch touchscreen mode via the HotTab:

1. Open HotTab utility by pressing  (Menu) Button located on the front panel, OR launching HotTab Utility application.
2. Choose “**Device ON/OFF**” and then click on “**Touch Set**” icon
3. The Touch Mode Select utility will be shown as below
4. Under the “**Touch Mode**”, select the desired touch modes by tapping on the radio button.
5. Here’s also additional Touch related setting to switch the touchscreen input between mouse mode with cursor, or with multi-touch mode:

Mouse Mode: Single touch point supported, with mouse cursor shown.

Multi-touch Mode: The default setting of the touch screen supports multi-touch mode (up to 10 points)

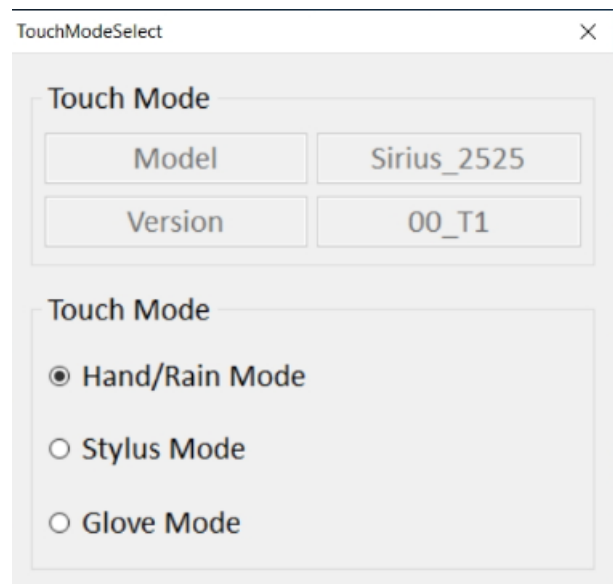

3.2.2 Switch via Programmable Function Buttons

To switch between the different touchscreen modes via the programmable function buttons, make sure the touchscreen mode switching is set to the programmable function buttons first.

1. Open HotTab utility by pressing  (Menu) Button located on the front panel, OR launching HotTab Utility application.
2. Tap on the **Setting** button.
3. Tap on **F1** icon.
4. Tap on the **Long Press** icon.
5. Change the Long Press function to “**Touch Mode**” as shown below:

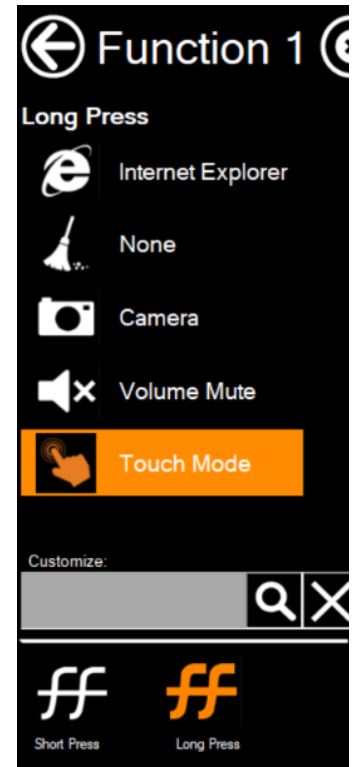

Once the touchscreen mode switching is set to the programmable function button, **Long Press** on “**F1**” function button to cycle through the different touchscreen modes. When touchscreen mode is switched, an icon will temporarily overlay on the lower center of the screen to indicate current touchscreen mode:

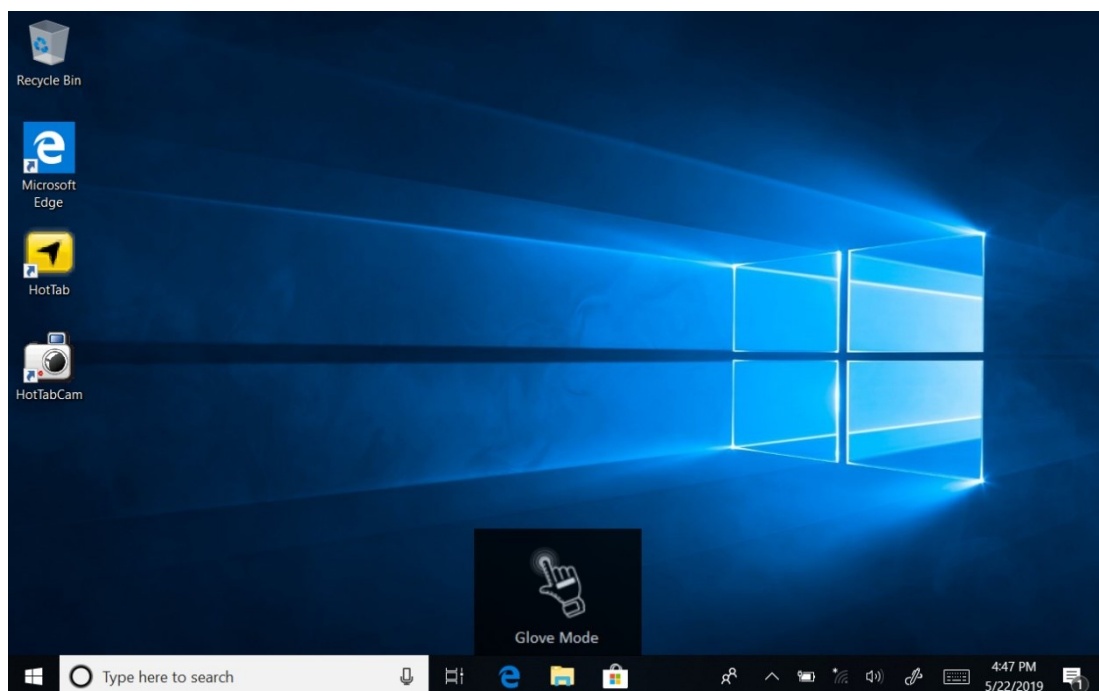



3.3 Using Camera

This Hottab menu option allows users take a picture or record a video. Before use, make sure the camera is powered on under Devices ON/OFF menu with the following scenarios.





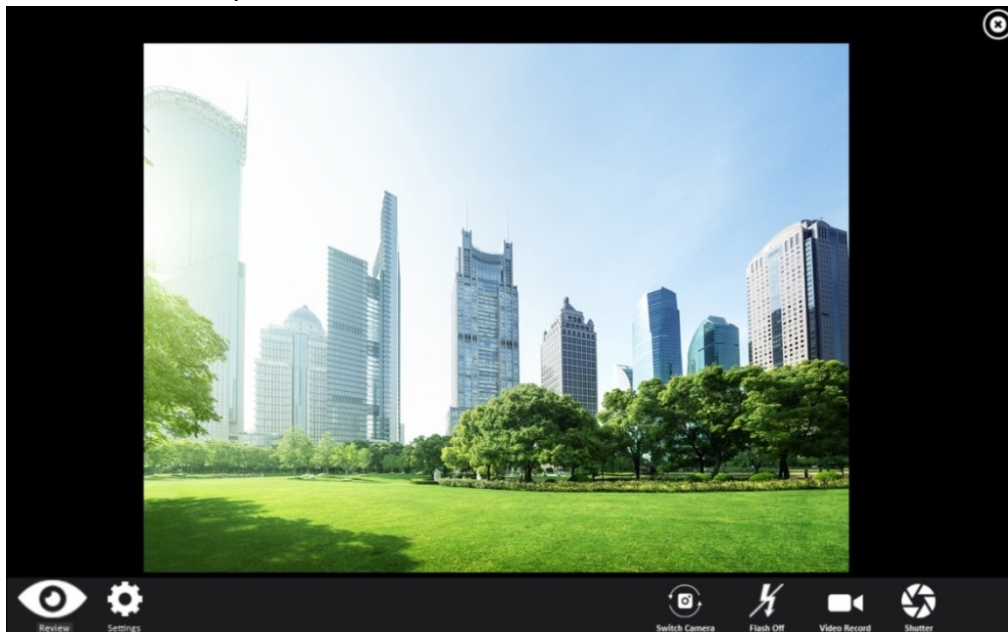

To open camera interface:

1. Press the  (Menu) button located on the front panel to open Hottab or launch the Hottab Utility.
2. Tap on "Device ON/OFF" button to check the built-in devices status.
3. Check the status color of the **Camera** icon:

Item	Status Color	Description
 Camera	Orange	Camera is enabled.
	White	Camera is disabled.

4. If the Camera is disabled (white), tap on the *Camera* icon to enable it (orange).
5. Go back to the Hottab main menu by pressing the  (Menu) button or clicking the back arrow.
6. Tap on the *Camera* icon to open Camera menu.



Item		Description
Review		Review
Settings		Opens Camera settings page. Available Settings: <ul style="list-style-type: none"> • Picture Save: modify/inspect saved location for pictures. • Video Save Folder: modify/inspect saved location for video recordings. • Picture Quality: Picture compression quality.
Camera Switch		Switch between front camera or rear camera.
Flash Control		Enables/ Disables LED Flash when taking picture.
Video Record		Tap to Start, and press again to stop recording.
Shutter Camera		Camera Shutter Button. Tap to take picture.
Exit		Exits the Camera and hide Hottab Utility.

3.4 Using Wireless Communications

This section describes how to get a quick access to set-up built-in devices, including turning on/off RF modules, setting up barcode reader, RFID reader, and expansion modules.

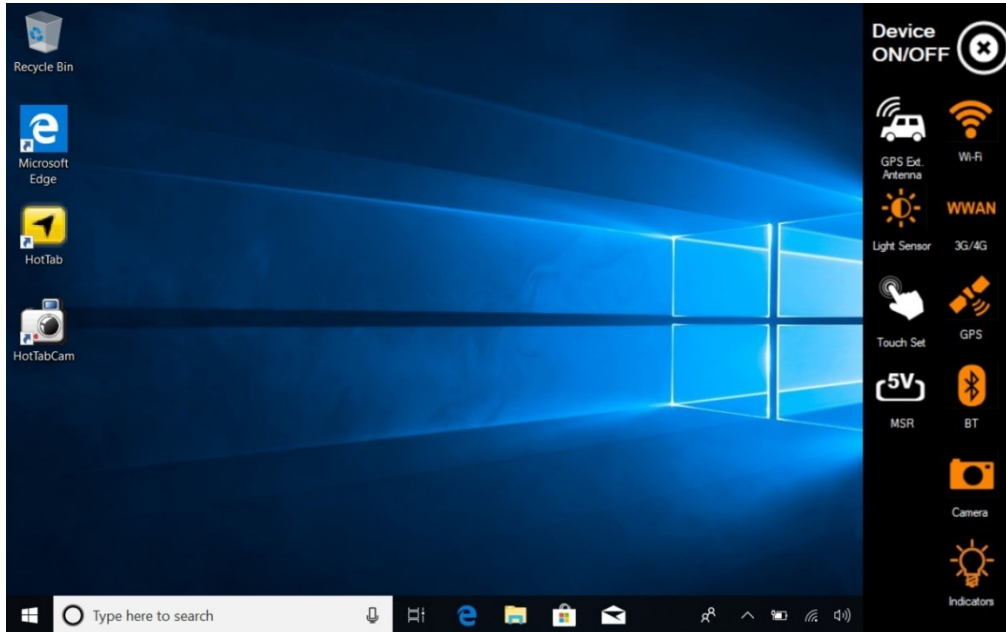

3.5 Using Barcode Reader

The Barcode Reader is an optional feature of M900P Tablet PC and is not re-workable by the end user.

To enable the Barcode Reader:

1. Open Hottab utility by pressing  (Menu) button located on the front panel or launching Hottab.
2. Tap on the **Device ON/OFF** button.
3. Check the status color of the **Barcode** icon.

Item	Status Color	Description
 Barcode	Orange	Barcode Reader is enabled. Use Fn3 button to trigger.
	White	Barcode Reader is disabled.

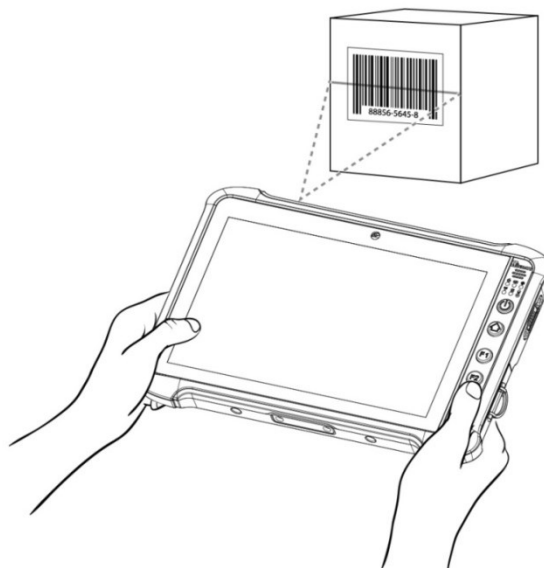

4. Open the application where barcode reader will be displaying the scanned barcode.
5. Trigger the barcode reader by pressing Fn3 function key.



3.6 Using HF RFID Reader

The HF RFID Reader is an optional feature of M900P tablet and is not re-workable by the end user. To use this feature, please make sure the tablet PC is built-in HF RFID reader before use, or contact our sales contact window for more details.

To enable the HF RFID Reader feature:

1. Open the Hottab utility by press the  (Menu) Button located on the front panel or launch the Hottab Utility application .
2. Tap on the **Device ON/OFF** button.
3. Tap on **RFID**, and the setting utility will show up as below:

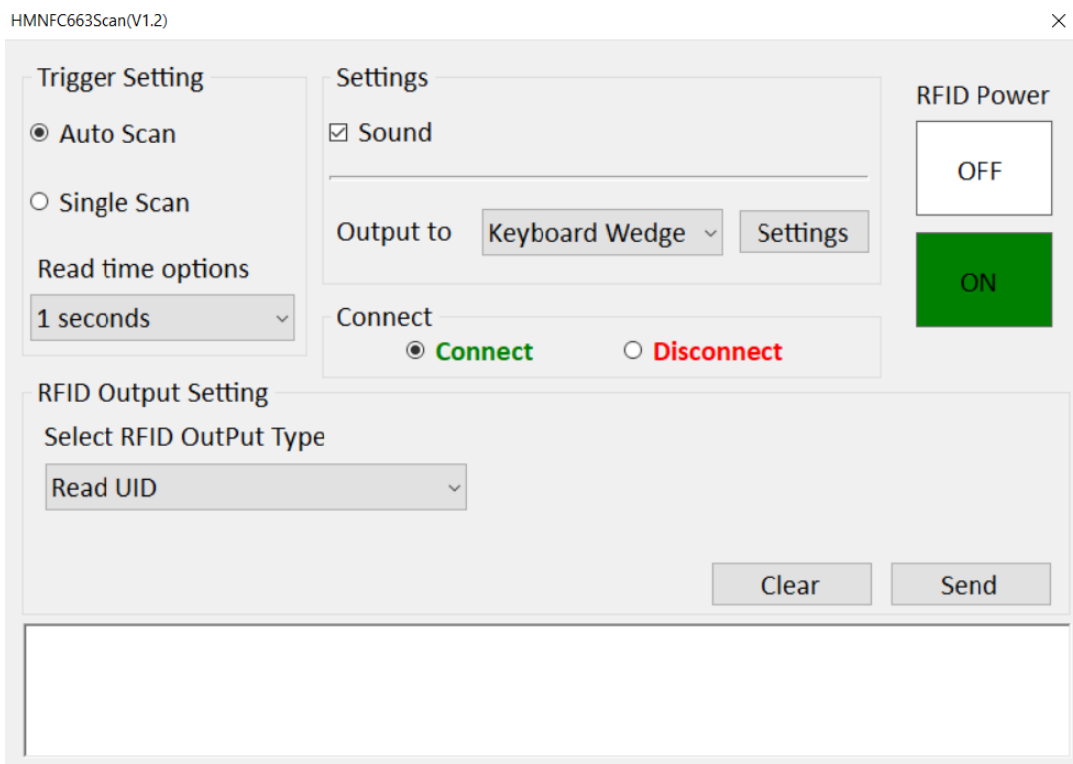

4. Tap on the **ON** button.
5. Check the status color of the ON icon is green, and the status color of the RFID icon on the Hottab menu is orange at the same time.

Item	Status Color	Description
	Orange	HF RFID Reader is enabled.
	White	HF RFID Reader is disabled.

6. To scan an RFID card hold a card next to RFID reader located on the bottom of the tablet.

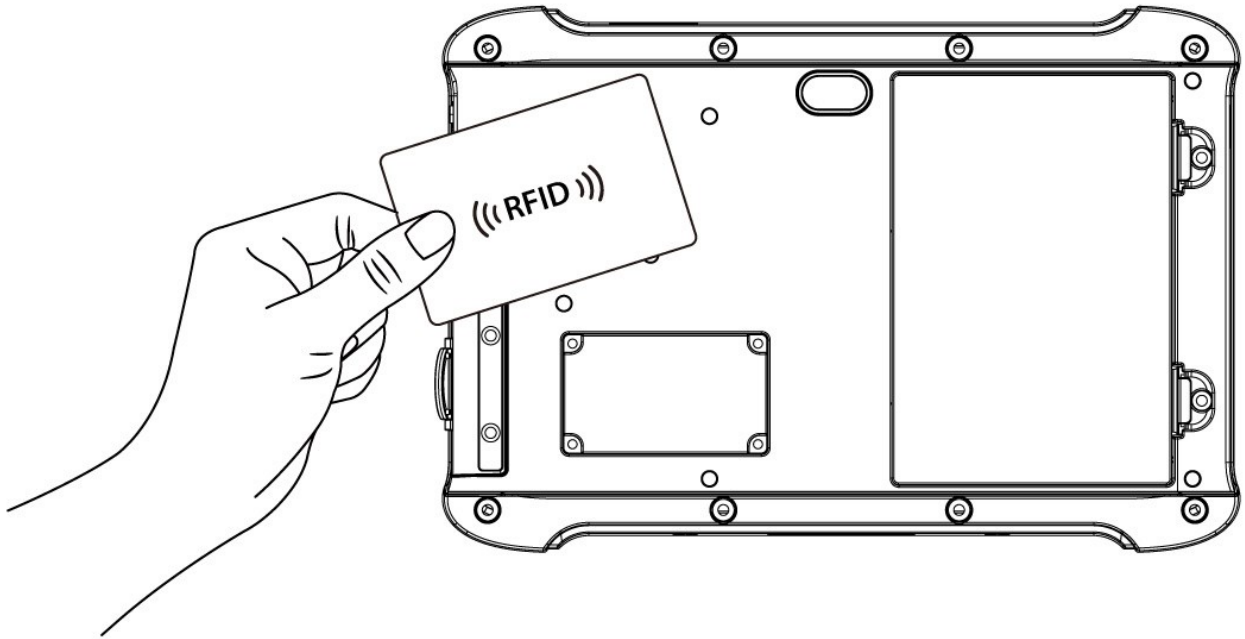

3.7 Using MSR/ EMV Card Reader

The MSR/ EMV Card Reader is an optional feature of M900P tablet and is designed to allow magnetic stripe (MSR) card transactions and ICC (Chip) card transactions from your tablet computer.

To use this feature, please make sure your tablet has built-in MSR/ EMV card reader before use, or contact our sales department for more details.

To read magnetic strip card MSR card swipe the card.

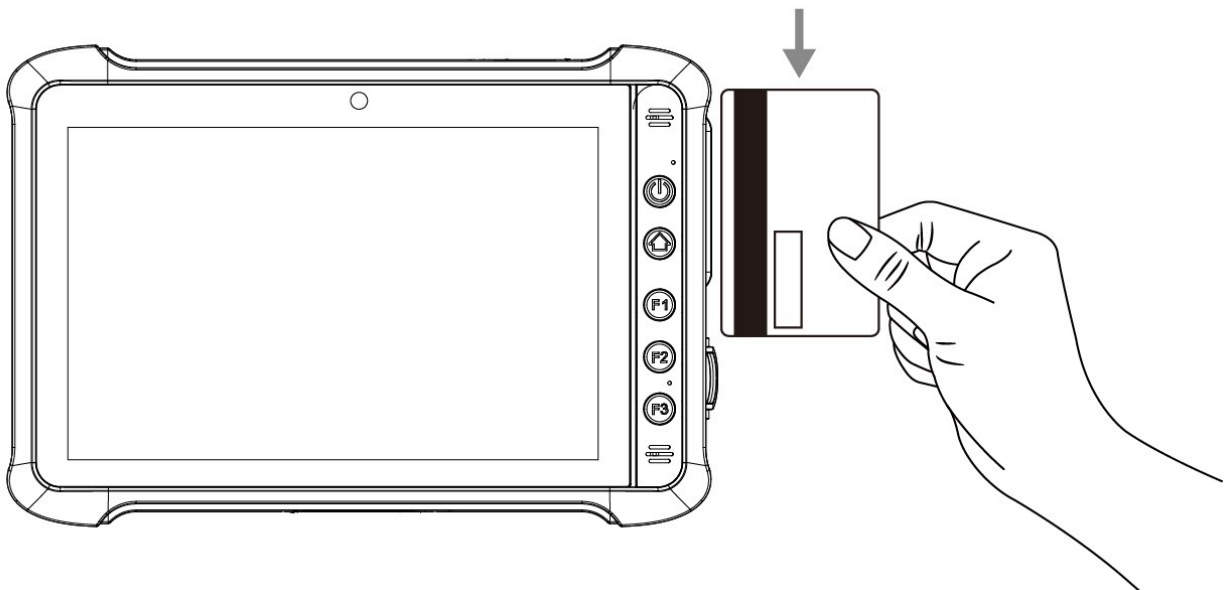

Appendix

Appendix A: Product Specifications

		Model Name
		M900P/ M900PT
Display Specification	Size	8-inch
	Resolution	1280 x 800
	Brightness	510 nits
	Contrast Ratio	800:1
	Viewing Angle	85/85/85/85
	Touch	10-point projected capacitive multitouch
System Specification	CPU	Intel® Pentium N4200 Apollo Lake, 1.10 GHz, up to 2.50 GHz with turbo boost technology
	System Memory	4 GB LPDDR4
	Storage	64 GB M.2 solid state drive (SSD) (up to 128GB), optional up to 512GB, up to 128GB additional storage with microSDXC card
	OS	Windows 10 IoT Enterprise (64 bit)
Interface	Docking Connector	1 x 19-pin docking connector
	USB	1 x USB3.0 (Type-A), 1 x USB3.0 (Type-C) Note: The USB Type-C connector follows USB 3.0 standard, which does not support Alternate Mode (ALT) or USB Power Delivery (USB-PD).
	Audio	1 x Audio Combo connector (Mic in or Line Out)
	Expansion Port	1 x D-Sub for Power Input, USB 2.0, Audio Out, and Tx/ Rx
	MicroSD Slot	1 x 1 x Micro SD Slot
	Power Input	1 x Power Jack
Audio	Microphone	Build-in
	Speaker	2 x 1Watt Speaker
Camera	Front Camera	2MP Webcam
	Rear Camera	8MP Rear Camera with Autofocus and LED Light
Data Capture	Barcode	1D/2D Barcode Scanner (Optional for M900P and M900PT)
	HF RFID	HF RFID Reader 13.56 MHz (Optional for M900P)
	LF RFID	LF RFID Reader 125 KHz (Optional for M900P)
	Smart Card Reader	MSR/ Smart Card Reader ISO 781017811 (Built-in for M900PT)
Security Function	Security	TPM v2.0
	MDM	SOTI Mobicontrol compatible
Keyboard and Input	Buttons	On-screen QWERTY Keyboard Buttons: 1 x Power, 1 x Home, 3 x function key
	LED Indicators	Power, Battery, HDD, RF
	Touch	10 point multitouch
Wireless Communications	WLAN	802.11 a/b/n/ac
	WWAN	4G/ LTE (Optional)
	Bluetooth	Bluetooth 5.0
	GPS	GPS, GLONASS
Power Management	Power Input	19V DC, 3.42A
	Battery	7.6V, typ. 4200 mAh Li Polymer Battery (2S2P)
	Battery Oper. Time	8 hours
	AC Adapter	100-240V, 50~60Hz
Mechanical Specification	Dimensions	225 x 148 x 20.5 mm (8.86 x 5.83 x 0.81 inches)
	Weight	0.9 kg
Environment	Operating Temp.	-20°C to 60°C (AC mode), -10°C to 50°C (Battery mode)
	Storage Temp.	-30°C to 70°C (-22°F to 158°F)
	Humidity	10% to 90% RH, non-condensing
	Shock	MIL-STD-810G Method 516.6 Procedure I
	Vibration	MIL-STD-810G Method 514.6 Procedure I
	Drop	5 feet to concrete
	IP Rating	IP65 certified, dustproof and waterproof
Certificates	Certification	CE, FCC, E-Mark



Winmate Inc.
9F, No.111-6, Shing-De Rd., San-Chung District,
New Taipei City 24158, Taiwan, R.O.C
www.winmate.com

Copyright © Winmate Inc. All rights reserved.