

# M-Series HMI

12.1"/ 15"/17"/19"/21.5" P-CAP touchscreen  
Intel® Atom™ E3845 1.91 GHz

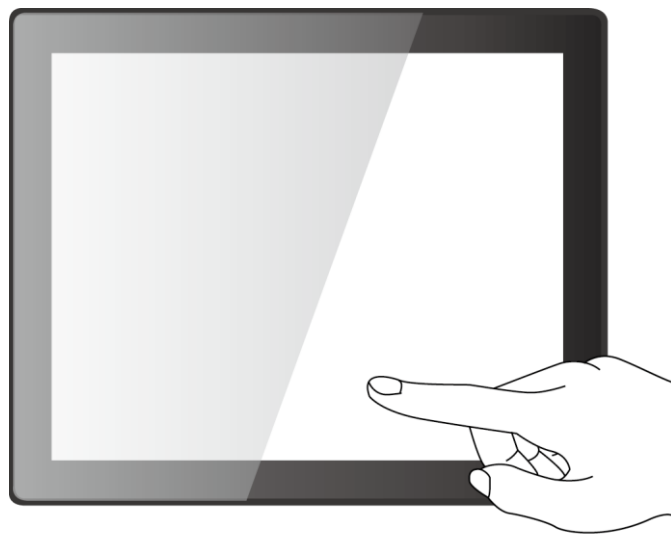

## Multifunctional Design

**Model No.:** R12IBWS-MHM2  
R15IBWS-MHC3  
R17IBWS-MHM1  
R19IBWS-MHA1  
W22IBWS-MHA3

## User Manual

Version 1.1  
Document Part Number: 9152111I100P

# CONTENTS

**PREFACE** ..... - 4 -

**ABOUT THIS USER MANUAL** ..... - 12 -

**CHAPTER 1: INTRODUCTION**..... - 14 -

    1.1 Product Features..... - 14 -

    1.2 Package Contents..... - 15 -

    1.3 Product Overview ..... - 16 -

    1.4 Dimensions..... - 17 -

        1.4.1 Dimensions 12.1” ..... - 17 -

        1.4.1 Dimensions 15” ..... - 18 -

        1.4.2 Dimensions 17” ..... - 19 -

        1.4.3 Dimensions 19” ..... - 20 -

        1.4.4 Dimensions 21.5” ..... - 21 -

**CHAPTER 2: GETTING STARTED**..... - 23 -

    2.1 Powering On..... - 23 -

        2.1.1 AC Adapter Components ..... - 23 -

        2.1.2 Power Considerations ..... - 24 -

        2.1.3 Connecting the Power ..... - 24 -

    2.2 Connector Pinouts ..... - 26 -

        2.2.1 Isolated DC in Connector ..... - 26 -

        2.2.2 Audio Out and Audio In ..... - 26 -

        2.2.3 COM1 Serial Port Connector ..... - 26 -

        2.2.4 HDMI Output Connector ..... - 27 -

        2.2.6 USB 2.0 Connector..... - 27 -

        2.2.7 VGA Output Connector ..... - 27 -

        2.2.8 LAN (RJ45) Connector..... - 28 -

    2.3 Configuring Serial Port Settings ..... - 29 -

    2.4 Turning On and Off ..... - 30 -

**CHAPETR 3: OPERATING THE DEVICE** ..... - 32 -

    3.1 Operating System..... - 32 -

    3.2 Multi-Touch..... - 33 -

    3.3 Adjusting the Display Brightness ..... - 34 -

**CHAPTER 4: DRIVER INSTALLATION ..... - 36 -**

- 4.1 Chipset Driver..... - 36 -
- 4.2 Graphics Driver ..... - 39 -
- 4.3 Audio Driver ..... - 40 -
- 4.4 Intel Sideband Fabric Device (Intel MBI) Driver (Windows 8) ..... - 41 -
- 4.5 Intel Trusted Engine Interface (Intel TXE) Driver ..... - 42 -
- 4.6 Intel Network Connections ..... - 43 -
- 4.7 USB 3.0 Driver (Windows 7)..... - 44 -

**CHAPTER 5: AMI UEFI BIOS SETUP ..... - 46 -**

- 5.1 When and How to Use BIOS Setup ..... - 46 -
- 5.2 BIOS Functions ..... - 46 -
  - 5.2.1 Main Menu ..... - 48 -
  - 5.2.2 Advanced Menu ..... - 49 -
  - 5.2.3 USB Configuration ..... - 52 -
  - 5.2.4 Chipset..... - 54 -
  - 5.2.5 Security..... - 57 -
  - 5.2.6 Boot ..... - 59 -
  - 5.2.7 Save & Exit..... - 61 -
- 5.3 Using Recovery Wizard to Restore Computer ..... - 63 -

**CHAPTER 6: MOUNTING ..... - 66 -**

- 6.1 Cable Mounting Considerations ..... - 66 -
- 6.2 Safety Precautions ..... - 67 -
- 6.3 Mounting Guide ..... - 68 -
  - 6.3.2 Panel Mounting ..... - 68 -
  - 6.3.1 VESA Mounting..... - 69 -

**CHAPTER 7: TECHNICAL SUPPORT ..... - 71 -**

- 7.1 Software Developer Support ..... - 71 -
  - 7.1.1 Winmate Download Center..... - 71 -
  - 7.1.2 Winmate File Share ..... - 71 -
- 7.2 Problem Report Form ..... - 72 -

**APPENDIX A: PRODUCT SPECIFICATIONS ..... - 74 -**

## PREFACE

### Copyright Notice

No part of this document may be reproduced, copied, translated, or transmitted in any form or by any means, electronic or mechanical, for any purpose, without the prior written permission of the original manufacturer.

### Trademark Acknowledgement

Brand and product names are trademarks or registered trademarks of their respective owners.

### Disclaimer

We reserve the right to make changes, without notice, to any product, including circuits and/or software described or contained in this manual in order to improve design and/or performance. We assume no responsibility or liability for the use of the described product(s) conveys no license or title under any patent, copyright, or masks work rights to these products, and make no representations or warranties that these products are free from patent, copyright, or mask work right infringement, unless otherwise specified. Applications that are described in this manual are for illustration purposes only. We make no representation or guarantee that such application will be suitable for the specified use without further testing or modification.

### Warranty

Our warranty guarantees that each of its products will be free from material and workmanship defects for a period of one year from the invoice date. If the customer discovers a defect, we will, at his/her option, repair or replace the defective product at no charge to the customer, provide it is returned during the warranty period of one year, with transportation charges prepaid. The returned product must be properly packaged in its original packaging to obtain warranty service. If the serial number and the product shipping data differ by over 30 days, the in-warranty service will be made according to the shipping date. In the serial numbers the third and fourth two digits give the year of manufacture, and the fifth digit means the month (e. g., with A for October, B for November and C for December).

For example, the serial number 1W14Axxxxxxx means October of year 2014.

## **Customer Service**

We provide a service guide for any problem by the following steps: First, visit the website of our distributor to find the update information about the product. Second, contact with your distributor, sales representative, or our customer service center for technical support if you need additional assistance.

You may need the following information ready before you call:

- Product serial number
- Software (OS, version, application software, etc.)
- Description of complete problem
- The exact wording of any error messages

In addition, free technical support is available from our engineers every business day. We are always ready to give advice on application requirements or specific information on the installation and operation of any of our products.

## Advisory Conventions

Four types of advisories are used throughout the user manual to provide helpful information or to alert you to the potential for hardware damage or personal injury. These are Notes, Important, Cautions, and Warnings. The following is an example of each type of advisory.

**NOTE:**

A note is used to emphasize helpful information

**IMPORTANT:**

An important note indicates information that is important for you to know.

**CAUTION/ ATTENTION**

A Caution alert indicates potential damage to hardware and explains how to avoid the potential problem.

Une alerte d'attention indique un dommage possible à l'équipement et explique comment éviter le problème potentiel.

**WARNING!/ AVERTISSEMENT!**

An Electrical Shock Warning indicates the potential harm from electrical hazards and how to avoid the potential problem.

Un Avertissement de Choc Électrique indique le potentiel de chocs sur des emplacements électriques et comment éviter ces problèmes.

**ALTERNATING CURRENT / MISE À LE TERRE!**

The Protective Conductor Terminal (Earth Ground) symbol indicates the potential risk of serious electrical shock due to improper grounding.

Le symbole de Mise à Terre indique le risqué potentiel de choc électrique grave à la terre incorrecte.

## Safety Information

### **WARNING! / AVERTISSEMENT!**

Always completely disconnect the power cord from your chassis whenever you work with the hardware. Do not make connections while the power is on. Sensitive electronic components can be damaged by sudden power surges. Only experienced electronics personnel should open the PC chassis.



Toujours débrancher le cordon d'alimentation du chassis lorsque vous travaillez sur celui-ci. Ne pas brancher de connexions lorsque l'alimentation est présente. Des composants électroniques sensibles peuvent être endommagés par des sauts d'alimentation. Seulement du personnel expérimenté devrait ouvrir ces chassis.

### **CAUTION/ATTENTION**

Always ground yourself to remove any static charge before touching the CPU card. Modern electronic devices are very sensitive to static electric charges. As a safety precaution, use a grounding wrist strap at all times. Place all electronic components in a static-dissipative surface or static-shielded bag when they are not in the chassis.



Toujours vérifier votre mise à la terre afin d'éliminer toute charge statique avant de toucher la carte CPU. Les équipements électroniques modernes sont très sensibles aux décharges d'électricité statique. Toujours utiliser un bracelet de mise à la terre comme précaution. Placer toutes les composantes électroniques sur une surface conçue pour dissiper les charges, ou dans un sac anti-statique lorsqu'elles ne sont pas dans le chassis.

## Safety Precautions

For your safety carefully read all the safety instructions before using the device. Keep this user manual for future reference.

- Always disconnect this equipment from any AC outlet before cleaning. Do not use liquid or spray detergents for cleaning. Use a damp cloth.
- For pluggable equipment, the power outlet must be installed near the equipment and must be easily accessible.
- Keep this equipment away from humidity.
- Put this equipment on a reliable surface during installation. Dropping it or letting it fall could cause damage.
- The openings on the enclosure are for air convection and to protect the equipment from overheating.



### CAUTION/ATTENTION

Do not cover the openings!

Ne pas couvrir les ouvertures!

- Before connecting the equipment to the power outlet make sure the voltage of the power source is correct.
- Position the power cord so that people cannot step on it. Do not place anything over the power cord.
- If the equipment is not used for a long time, disconnect it from the power source to avoid damage by transient over-voltage.
- Never pour any liquid into an opening. This could cause fire or electrical shock.
- Never open the equipment. For safety reasons, only qualified service personnel should open the equipment.
- All cautions and warnings on the equipment should be noted.

**\*Let service personnel to check the equipment in case any of the following problems appear:**

- The power cord or plug is damaged.
  - Liquid has penetrated into the equipment.
  - The equipment has been exposed to moisture.
  - The equipment does not work well or you cannot get it to work according to the user manual.
  - The equipment has been dropped and damaged.
  - The equipment has obvious signs of breakage.
- Do not leave this equipment in an uncontrolled environment where the storage temperature is below -20°C (-4°F) or above 60°C (140°F). It may damage the equipment.



**CAUTION/ATTENTION**

Use the recommended mounting apparatus to avoid risk of injury.  
Utiliser l'appareil de fixation recommandé pour éliminer le risque de blessure.

**WARNING! / AVERTISSEMENT!**

Only use the connection cords that come with the product. When in doubt, please contact the manufacturer.

Utiliser seulement les cordons d'alimentation fournis avec le produit. Si vous doutez de leur provenance, contactez le fabricant.





**WARNING! / AVERTISSEMENT!**

Always ground yourself against electrostatic damage to the device.

Toujours vérifier votre mise à la terre afin que l'équipement ne se décharge pas sur vous.

- Cover workstations with approved anti-static material. Use a wrist strap connected to a work surface and properly grounded tools and equipment.
- Use anti-static mats, heel straps, or air ionizer for added protection.
- Handle electrostatic-sensitive components, PCB's and assemblies by the case or the edge of the board.
- Avoid contact with pins, leads, or circuitry.
- Turn off power and input signals before inserting and removing connectors or test equipment.
- Keep the work area free of non-conductive materials, such as ordinary plastic assembly aids and Styrofoam.
- Use filed service tools, such as cutters, screwdrivers, and vacuum cleaners that are conductive.
- Always put drivers and PCB's component side on anti-static foam.

## Important Information

Countries/ Area	Symbol	This equipment complies with essential requirements of:
European Union 		Electromagnetic Compatibility Directive (2014/30/EU) Low Voltage Directive (2014/35/EU) Restrictions of the use of certain hazardous substances (RoHS) Directive (2011/65/EU)
USA 		FCC Part 15 Subpart B Regulations Class B

## Federal Communications Commission Radio Frequency Interface Statement



This device complies with part 15 FCC rules.

Operation is subject to the following two conditions:

- This device may not cause harmful interference.
- This device must accept any interference received including interference that may cause undesired operation.

This equipment has been tested and found to comply with the limits for a class "B" digital device, pursuant to part 15 of the FCC rules. These limits are designed to provide reasonable protection against harmful interference when the equipment is operated in a commercial environment. This equipment generates, uses, and can radiate radio frequency energy and, if not installed and used in accordance with the instruction manual, may cause harmful interference to radio communications. Operation of this equipment in a residential area is likely to cause harmful interference in which case the user will be required to correct the interference at him own expense.

## European Union



This equipment is in conformity with the requirement of the following EU legislations and harmonized standards. Product also complies with the Council directions.

### **Electromagnetic Compatibility Directive (2014/30/EU)**

- EN55024: 2010/ A1: 2015
  - IEC61000-4-2: 2009
  - IEC61000-4-3: 2006+A1: 2007+A2: 2010
  - IEC61000-4-4: 2012
  - IEC61000-4-5: 2014
  - IEC61000-4-6: 2014
  - IEC61000-4-8: 2010
  - IEC61000-4-11: 2004
- EN55032: 2012/AC:2013
- EN61000-3-2:2014
- EN61000-3-3:2013

### **Low Voltage Directive (2014/35/EU)**

EN 60950-1:2006/A11:2009/A1:2010/A12:2011/ A2:2013

## ABOUT THIS USER MANUAL

This User Manual provides information about using the Winmate® M-Series HMI with Intel® Atom™ E3845 1.91 GHz processor. The documentation set for the M -Series HMI provides information for specific user needs, and includes:

- **M-Series HMI User Manual** – contains detailed description on how to use the HMI, its components and features.
- **M-Series HMI Quick Start Guide** - describes how to get the HMI device up and running.



**NOTE:**

Some pictures in this guide are samples and can differ from actual product

### Revision History

Version	Date	Note
1.0	21-Mar-2016	Initial release
1.1	11-Jul-2016	Modify mounting solutions

## **INTRODUCTION**

This chapter gives you product overview, describes features and hardware specification. You will find all accessories that come with the HMI device in the packing list. Mechanical dimensions and drawings included in this chapter.



## CHAPTER 1: INTRODUCTION

M-Series HMI is designed to provide versatile and cost-effective solution for your industrial needs. P-cap multi-touch screen equipped with industrial motherboard offers various input/ output connectors. Intel® Atom™ E3845 1.91 GHz processor onboard with fanless cooling system assures steady performance and silent functioning.

M-Series HMI perfectly fits in applications where total costs of ownership (TCO) and quick recovery of failure is important. The flexible system design provides easy access to components and can be serviced by local maintenance team.

Versatile, easy-to-service and upgradable M-Series HMI is the best solution for industrial and building automation.

### 1.1 Product Features







Winmate® M-Series HMI has the following features:

- Signature true flat display screen with edge-to-edge design
- Aluminum, anti-corrosion treated housing
- Superior Sealing with front IP65 protection against dust and water
- Projected Capacitive Multi-Touch (P-CAP)
- Fanless cooling system
- Modular Design
- Support wide range 12-24V DC input
- One Quick & Easy Removable 2.5" SSD Bay Slot

## 1.2 Package Contents

Carefully remove the box and unpack your HMI device. Please check if all the items listed below are inside your package. If any of these items are missing or damaged contact us immediately.

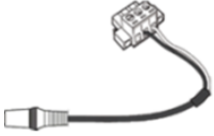
Standard factory shipment list:

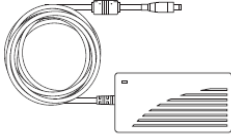
			
<p><b>HMI Device</b></p>	<p><b>Quick Start Guide (Hardcopy)</b></p>	<p><b>Driver CD</b></p>	<p><b>Mounting Clips &amp; Screws</b>                      12.1" HMI – 8 pcs                      15" HMI – 12 pcs                      17"/ 19" HMI – 14 pcs                      21.5" HMI – 16 pcs</p>
			
<p><b>3-pin Terminal Block</b></p>	<p><b>Power Cord</b></p>	<p><b>AC Adapter (12V/ 80W)</b></p>	

### 1.3 Product Overview

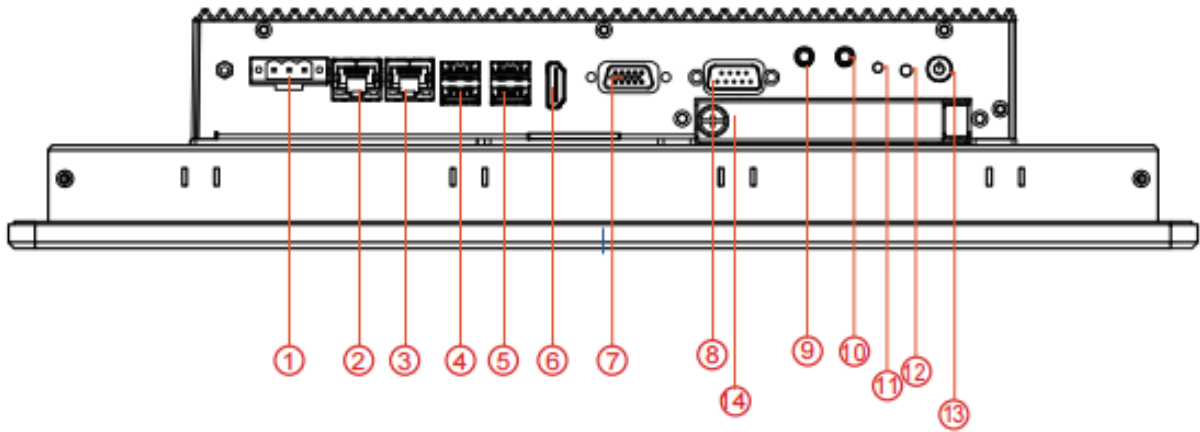

No	Description	No	Description
①	12-24V DC in	⑧	COM1
②	LAN	⑨	Audio in
③	LAN	⑩	Audio out
④	USB 2.0 x 2	⑪	HDD indicator
⑤	USB 2.0 x 2	⑫	Reset
⑥	HDMI output	⑬	Power Button
⑦	VGA output	⑭	2.4" SSD Bay



## 1.4 Dimensions

This section contains mechanical drawing of the HMI devices. Notice that this is a simplified drawing and some components are not marked in detail.

### 1.4.1 Dimensions 12.1"

*Unit: mm*

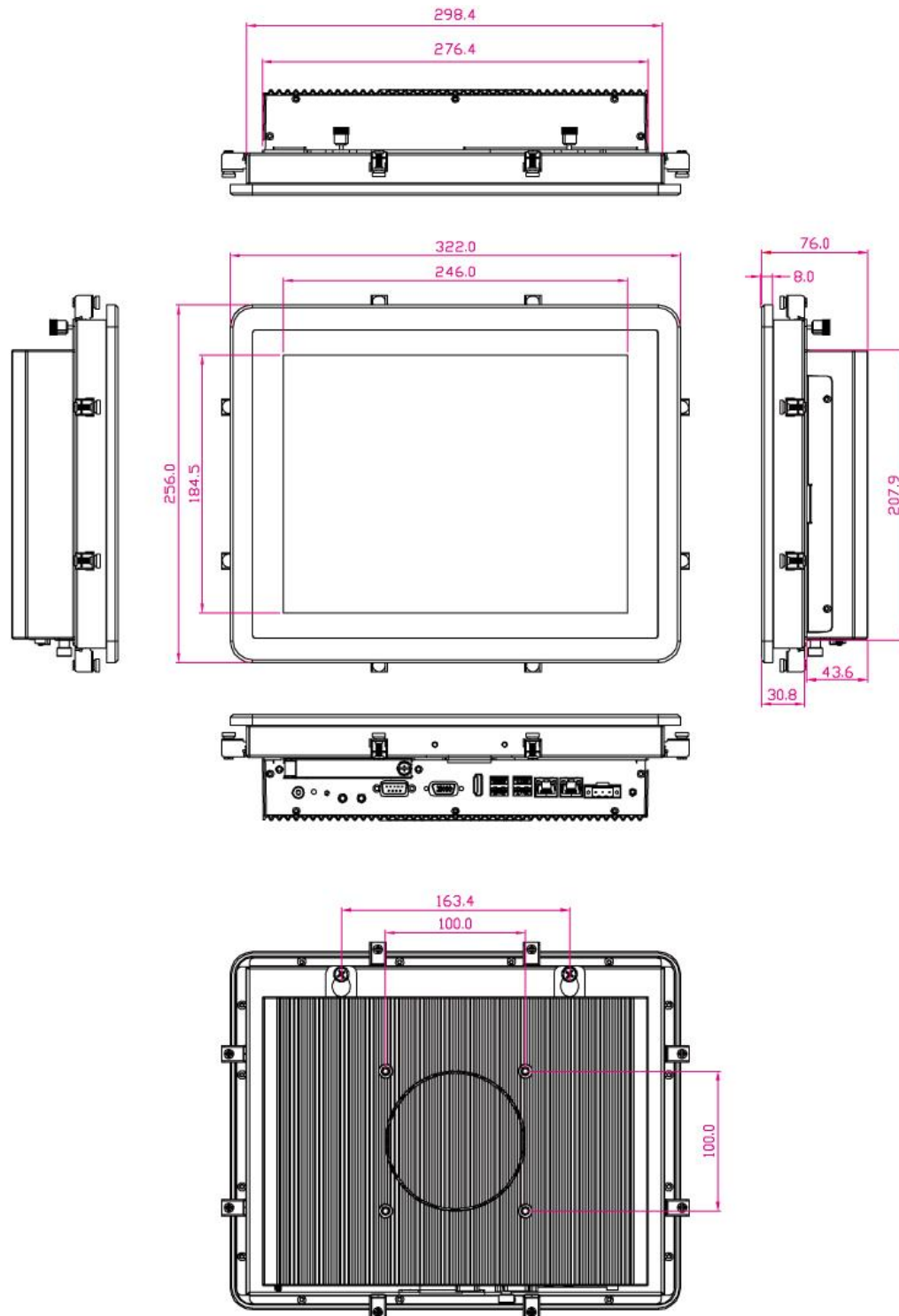

### 1.4.1 Dimensions 15"

Unit: mm

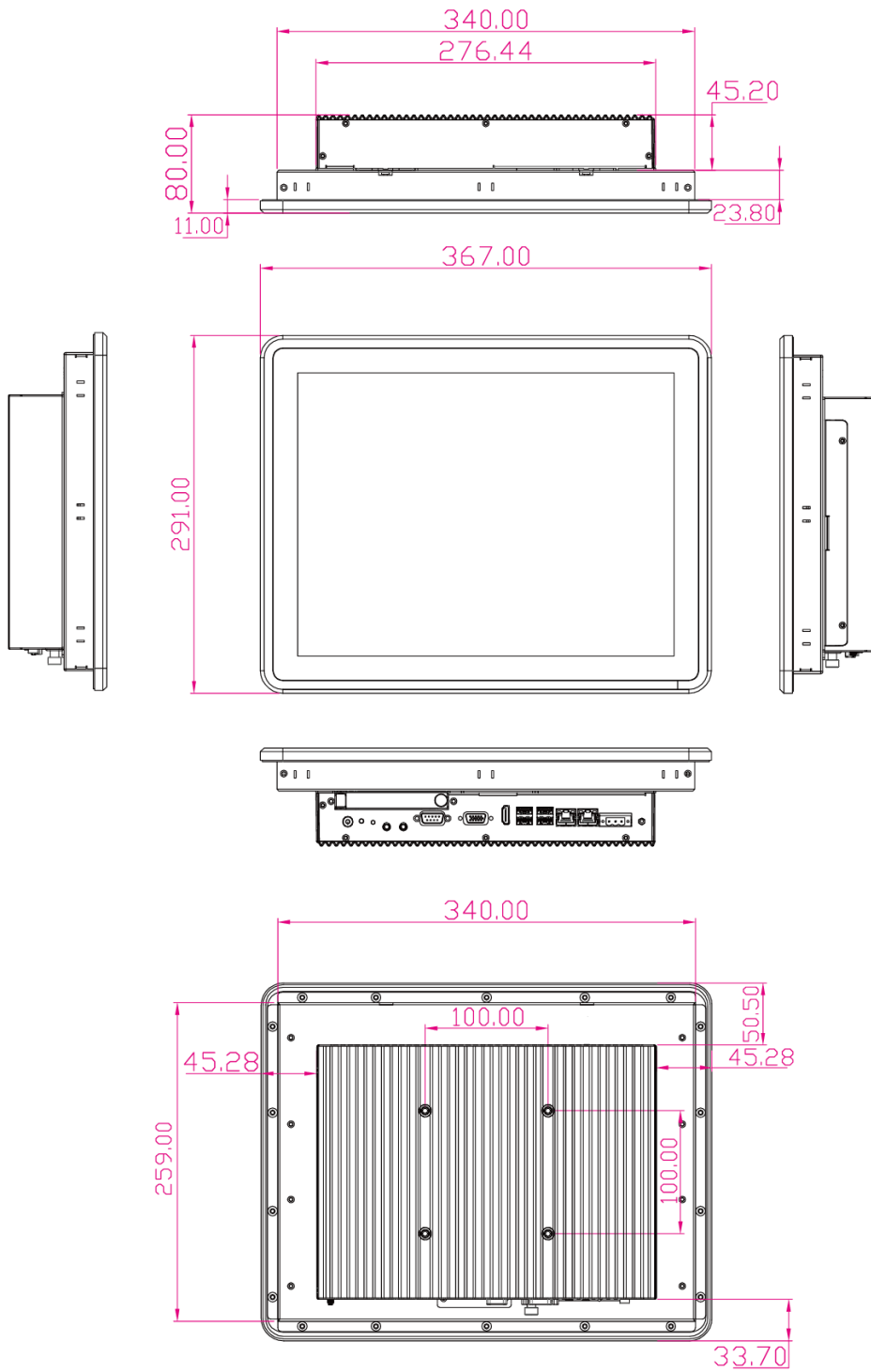

### 1.4.2 Dimensions 17"

Unit: mm

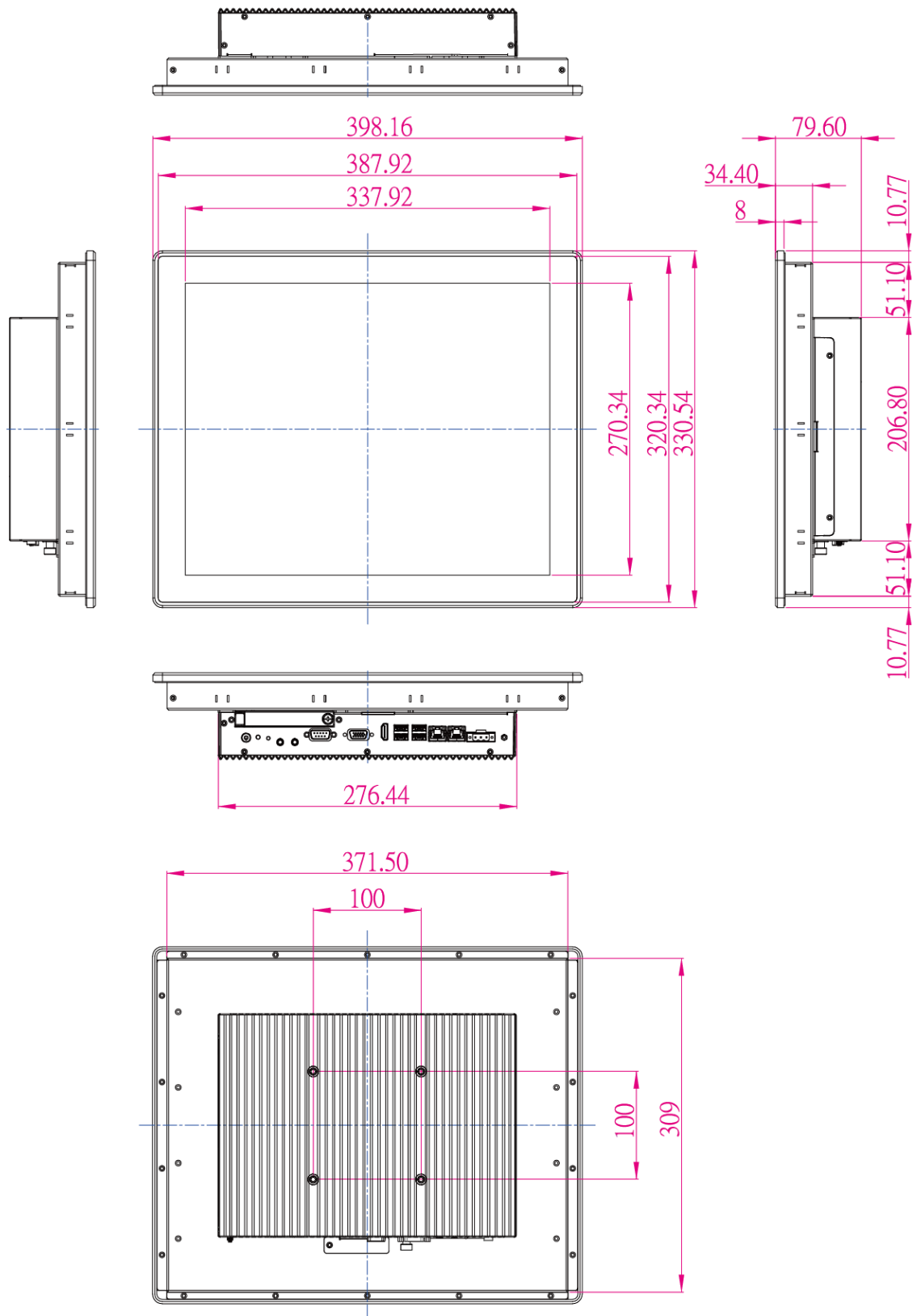

### 1.4.3 Dimensions 19"

Unit: mm

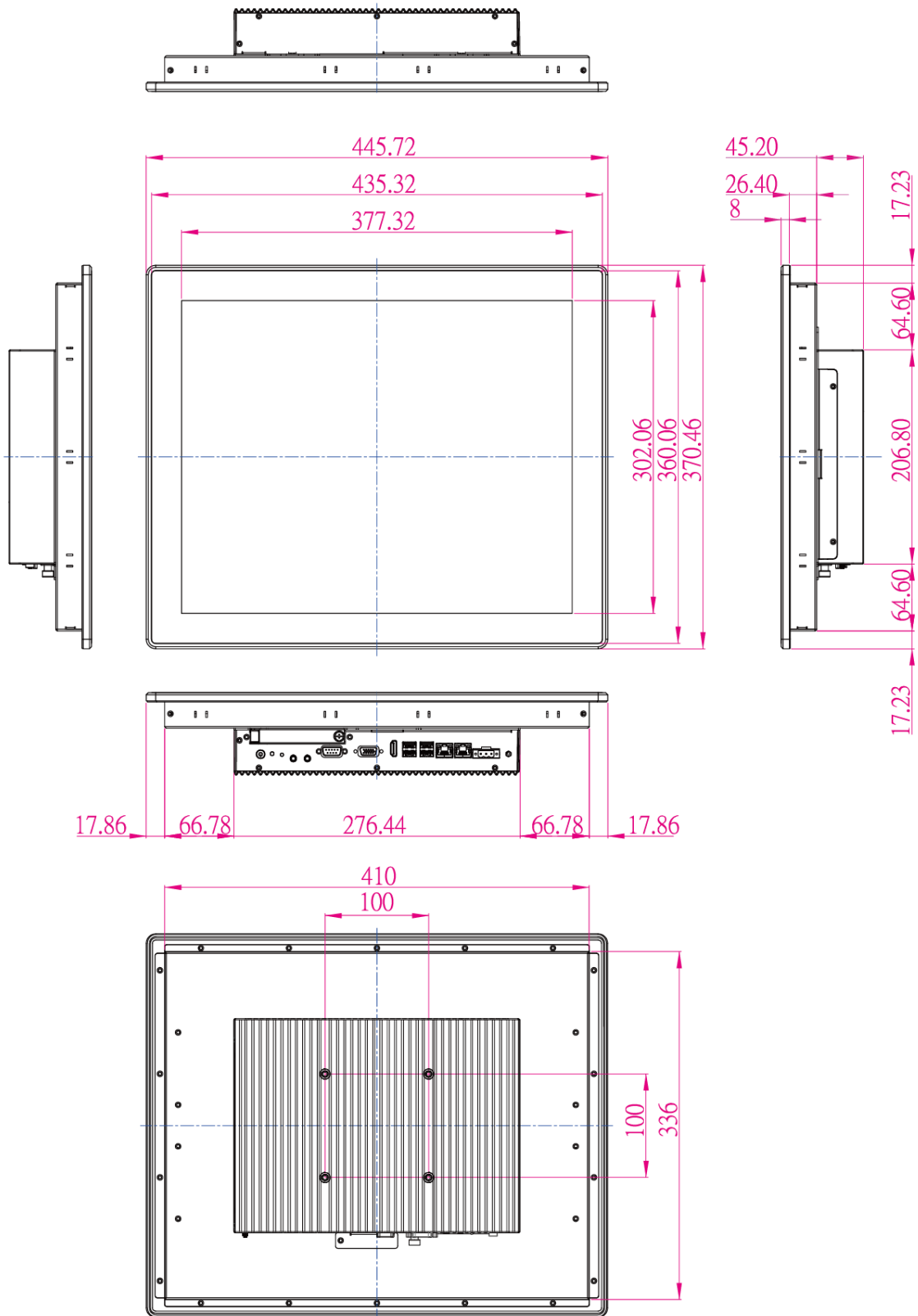

### 1.4.4 Dimensions 21.5"

Unit: mm

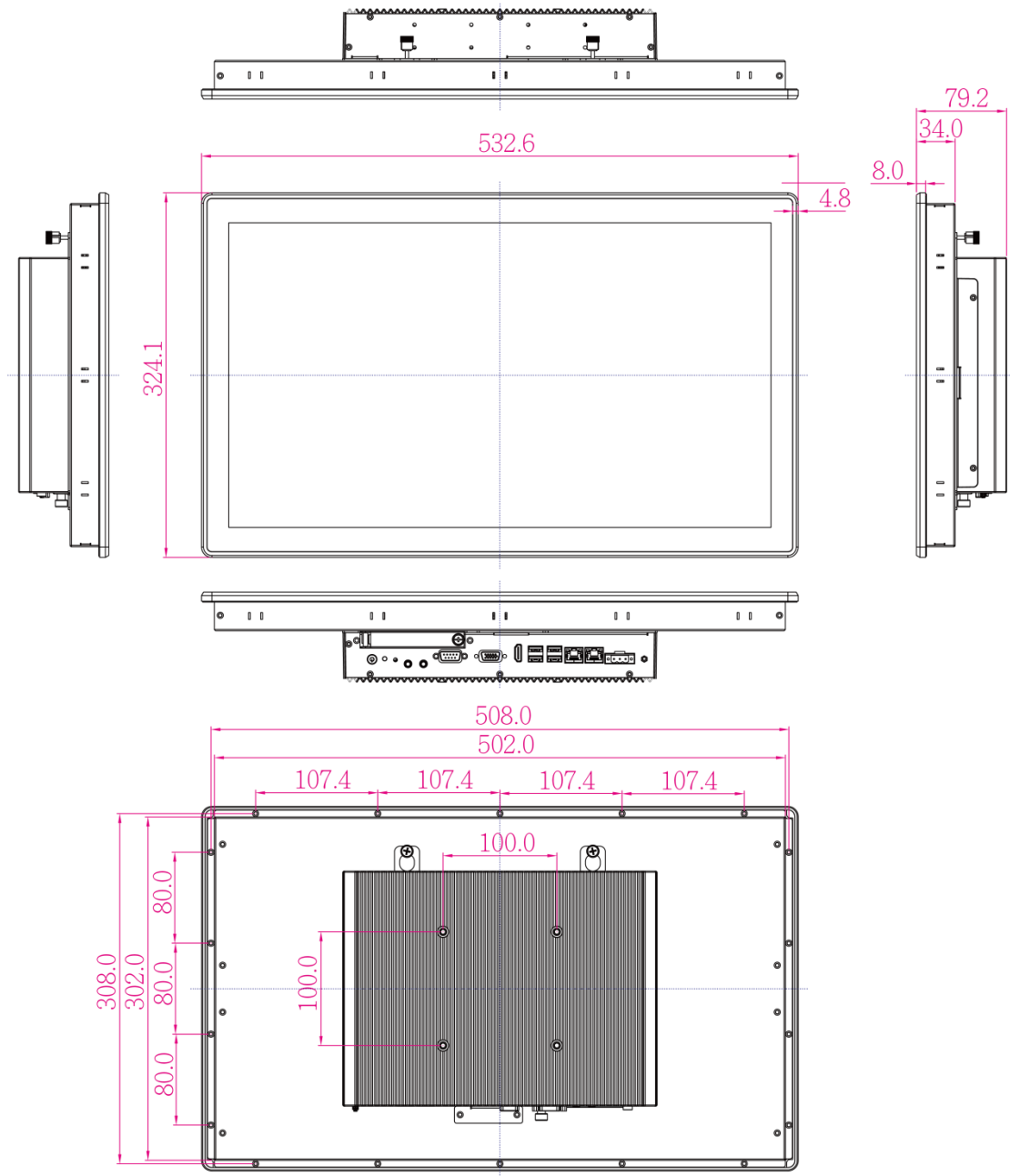

## **GETTING STARTED**

This chapter tells you important information on power supply, adapter and precautions tips. Pay attention to power considerations.





## CHAPTER 2: GETTING STARTED

This chapter provides information on how to connect the HMI device to the source of power, connector pinouts and the guideline to turn on/off the HMI device.

### 2.1 Powering On

This section explains how to power on the HMI device. Pay attention to the precautions.

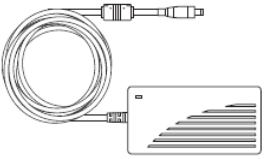
#### 2.1.1 AC Adapter Components

		
<p><b>AC Adapter (12V/80W)</b></p>	<p><b>Power Cord</b></p>	<p><b>3-Pin Terminal Block to DC Jack</b></p>

#### Safety Precautions:

- Do not use the adapter in a high moisture environment
- Never touch the adapter with wet hands or foot
- Allow adequate ventilation around adapter while using
- Do not cover the adapter with paper or other objects that will reduce cooling
- Do not use the adapter while it is inside a carrying case
- Do not use the adapter if the cord is damaged
- There are NO serviceable parts inside
- Replace the unit if it is damaged or exposed to excess moisture

#### While using the AC Adapter always:

- Plug-in the power cord to easy accessible AC outlet
- Plug-in the AC adapter to a grounded outlet



#### **ALTERNATING CURRENT / MISE À LE TERRE!**

This product must be grounded. Use only a grounded AC outlet. Install the additional PE ground wire if the local installation regulations require it.

Ce produit doit être mis à la terre. Utiliser seulement un cordon d'alimentation avec mise à la terre. Si les règlements locaux le requiert, installer des câbles de mise à la terre supplémentaires.

## **2.1.2 Power Considerations**

The HMI device operates on external DC power. Use the AC adapter included in the package.



### **CAUTION/ATTENTION**

Use only the AC adapter included in your package (Rating: Output 12V/ 6.6A). Using other AC adapters may damage the device.  
Utiliser seulement le convertisseur AC inclu avec votre appareil (Puissance: Sortie 12V/ 6.6A). Utiliser d'autres convertisseurs pourraient endommager l'appareil.

## **2.1.3 Connecting the Power**

### **2.1.3.1 Connecting to AC Power Source**

To connect the HMI to AC power source:

1. Plug one end of the terminal block cable firmly to the DC IN Jack.
2. Plug the other end of the terminal block plug to the AC adapter.
3. Connect the AC adapter to the power cord.
4. Plug the power cord to a working AC outlet. The device will boot automatically.

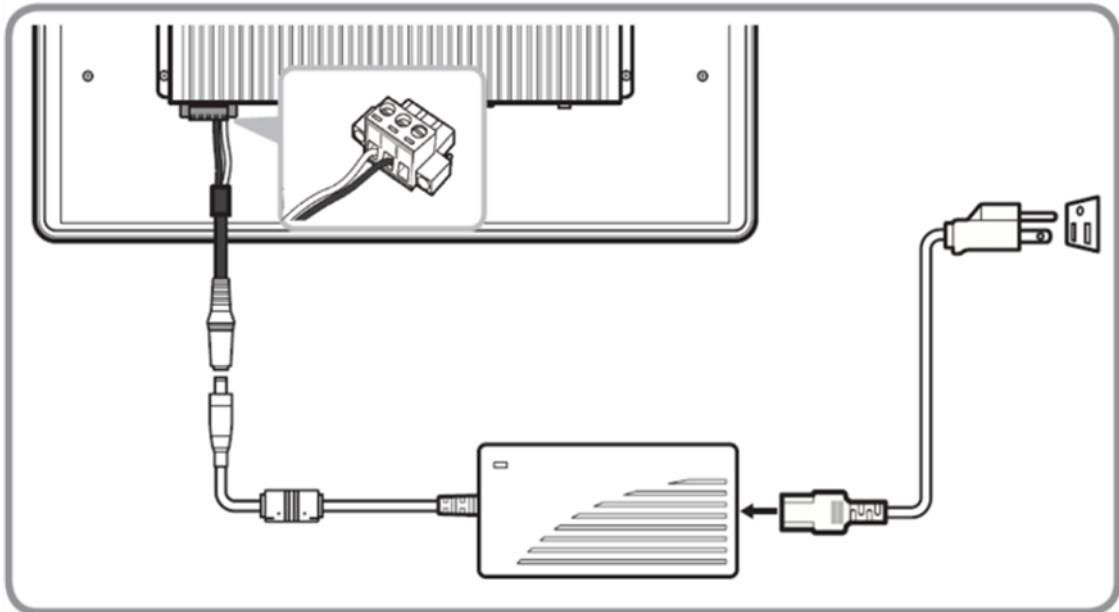

### **Note:**

Power cords vary in appearance by region and country.



### 2.1.3.2 Connecting to DC Power Source

To connect the HMI to DC power source:

1. Insert the exposed wires of the DC Power Cable to the appropriate connectors on the terminal block plug.
2. Plug the terminal block plug firmly to the DC IN Jack.
3. Connect the other end of the DC power cable (wires with lug terminals that are labeled + and – to the terminals of the 12-24V DC Power Source. Ensure that the power connections maintain the proper polarity.

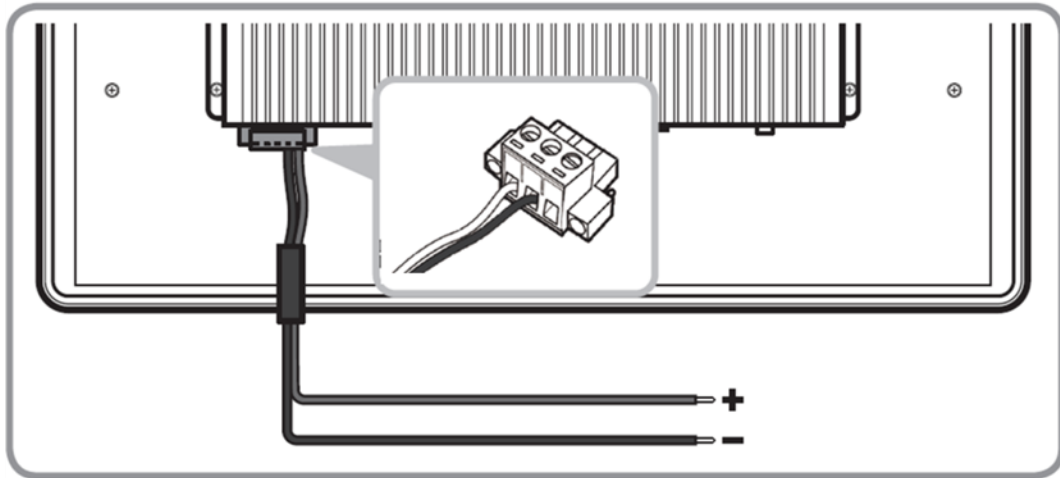

## 2.2 Connector Pinouts

### 2.2.1 Isolated DC in Connector

The M-Series HMI uses an isolated 3pin terminal block that accepts 12~24V DC.

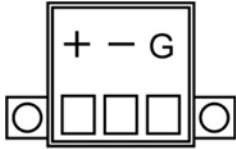

 <b>Voltage</b>	Minimum Voltage 12V
	Maximum Voltage 24V
	Maximum Current 6.6A

### 2.2.2 Audio Out and Audio In

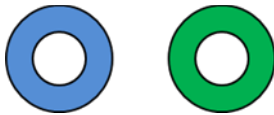

Color	Signal Name
Blue	Line In
Green	Line Out

### 2.2.3 COM1 Serial Port Connector

The M-Series HMI uses D-SUB 9pin connector to connect serial interfaces.

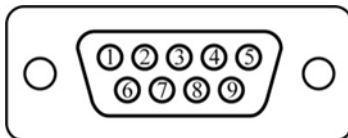

Pin No	RS-232 (Default)	RS-422	RS-485
1	DCD	TxD-	D-
2	RXD	TxD+	D+
3	TXD	RxD+	NC
4	DTR	RxD-	NC
5	GND	GND	GND
6	DSR	NC	NC
7	RTS	NC	NC
8	CTS	NC	NC
9	RI	NC	NC

Serial COM1 settings can be configured for RS-232, RS-422 or RS-485 by jumpers. Refer to [Ch.2, Configuring Serial Port Settings](#) section of this user manual for the instruction on how to configure COM1 serial port settings.

### 2.2.4 HDMI Output Connector

Use HDMI A Type19-pin female output connector to connect the HMI device to an external display.



Pin No	Signal Name	Pin No	Signal Name
1	TMDS_DATA2+	2	GND
3	TMDS_DATA2-	4	TMDS_DATA1+
5	GND	6	TMDS_DATA1-
7	TMDS_DATA0+	8	GND
9	TMDS_DATA0-	10	TMDS_CLOCK+
11	GND	12	TMDS_CLOCK-
13	CEC	14	NC
15	DDC_CLOCK	16	DDC_DATA
17	GND	18	5V
19	Hot Plug Detect		

### 2.2.6 USB 2.0 Connector

M-Series HMI has two USB2.0 connectors. Use USB2.0 connector to connect external devices such as mouse or keyboard to the HMI device



Pin No	Signal Name	Pin No	Signal Name
1	+5V	2	Data-
3	Data+	4	GND

### 2.2.7 VGA Output Connector

M-Series HMI has VGA connector (D-Sub 15pin Female). Use VGA cable to connect the display to the PC system.

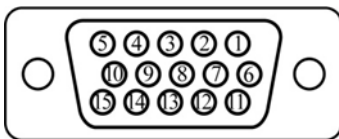

Pin No	Signal Name	Pin No	Signal Name
1	RED	2	GREEN
3	BLUE	4	ID2/RES
5	GND	6	RED_RTN
7	GREEN_RTN	8	BLUE_RTN
9	KEY/PWR	10	GND
11	ID0/RES	12	ID1/SDA
13	HSync	14	VSynC
15	ID3/SCL		

## **2.2.8 LAN (RJ45) Connector**

M-Series HMI supports one RJ45 10/100/1000 Mbps Ethernet interface for connecting to the internet.

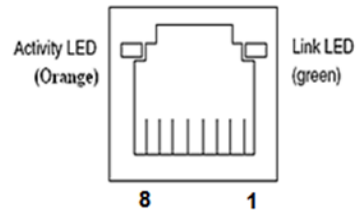

Pin No	Signal Name	Pin No	Signal Name
1	TX1+	2	TX1-
3	TX2+	4	TX2-
5	TX3+	6	TX3-
7	TX4+	8	TX4-

## 2.3 Configuring Serial Port Settings

Serial Port COM1 can be configured for RS-232, RS-422 or RS-485. Jumpers are located on the motherboard. You need to open the housing in order to access the jumpers.



**CAUTION/ ATTENTION**

It is recommended to use factory jumper settings. Opening the housing when it is sealed may damage the device and its parts.

Il est recommandé d'utiliser la configuration d'usine de cavalier. Ouvrir le châssis lorsqu'il est scellé peut endommager l'appareil et ses pièces.



**Note:**

A pair of needle nose pliers may be helpful when working with jumpers. If you have any doubts about the best hardware configuration for your application, contact your local distributor or sales representative before you make any changes. Generally, you simply need a standard cable to make most connections.

The jumper setting diagram is shown below. When the jumper cap is placed on both pins, the jumper is SHORT. The illustration below shows a 3-pin jumper; pins 1 and 2 are short. If you remove the jumper cap, the jumper is OPEN.

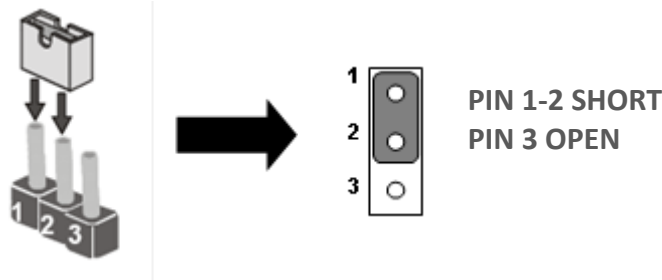

The picture below shows RS-232/422/485 (J8/J9) jumper setting.

RS232		RS422		RS485	
JP8	JP9	JP8	JP9	JP8	JP9
<p>RS232</p>	<p>RS232</p>	<p>RS422</p>	<p>RS422/485</p>	<p>RS485</p>	<p>RS422/485</p>

**Example:** To make RS-232 Settings, set the Jumper 8 Pin 1-2 to the SHORT position, and Jumper 9 Pin1-2, 4-5, 7-8, 10-11 to the SHORT position.

## 2.4 Turning On and Off

The unit is configured to **Power ON** when the HMI device is connected to the power source.

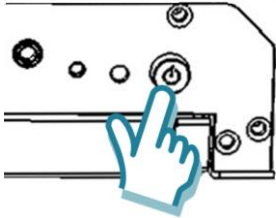

Press the **Power** button to restart the machine when the unit has been shut down.

If the system hangs, press the Reset button (beside the power button) to restart the device.

You can **Turn OFF** the HMI device with the Windows power settings.

1. Tap **Start**  > **Shut down**.
2. Wait for your HMI device to completely turn off before disconnecting the power cord (*if necessary*).

## **OPERATING THE DEVICE**

This chapter provides detailed information on how to operate the device. If you have been using touch-screen Panel PCs before, the interface may look familiar. Sections include system settings parameters.



## CHAPETR 3: OPERATING THE DEVICE

In this chapter you will find instructions on how to use multi-touch on the Windows-based HMI device.

### 3.1 Operating System

M-series HMI support several versions of Windows OS: Windows 10 IoT Enterprise, Windows Embedded 8 Standard, and Windows Embedded Standard 7 – WS7P.









**IMPORTANT:**

The device is shipped with the OS System according to your order. Contact us if you have any questions regarding OS settings.

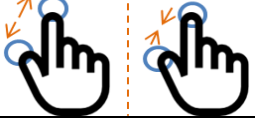

### 3.2 Multi-Touch

The touchpad supports the core gestures for Windows

Gesture	Windows Usage	Gesture Action	Action
Tap/ Double-tap	Click / Double-click	Click or double-click	
Panning with Inertia	Scrolling	Drag one or two fingers up and down	
Selection/ Drag (left to right with one finger)	Mouse-drag/ Selection	Drag one finger left/right	
Zoom	Zoom (default to CTRL key + scroll wheel)	Move two fingers apart/ toward each other	
Rotate	No system default unless handled by Application (using WM_Gesture API)	Move two fingers in opposite directions <i>or</i> Use one finger to pivot around another	
Two-Finger tap	N/A - Exposed through Gesture API, used by Application discretion	Tap two fingers at the same time (where the target is the midpoint between fingers)	
Press and Hold	Right-click	Press, wait for blue- ring animation to complete, then release	
Flicks	Default: Pan Up/ Down/ Back, and Forward	Make quick drag gestures in the described direction	

\* Reference from Microsoft®

### 3.3 Adjusting the Display Brightness

1. Tap **Start**  > **Control Panel** > **Hardware and Sound** > **Power Options**.
2. Drag the brightness bar to adjust the brightness level according to your preference.

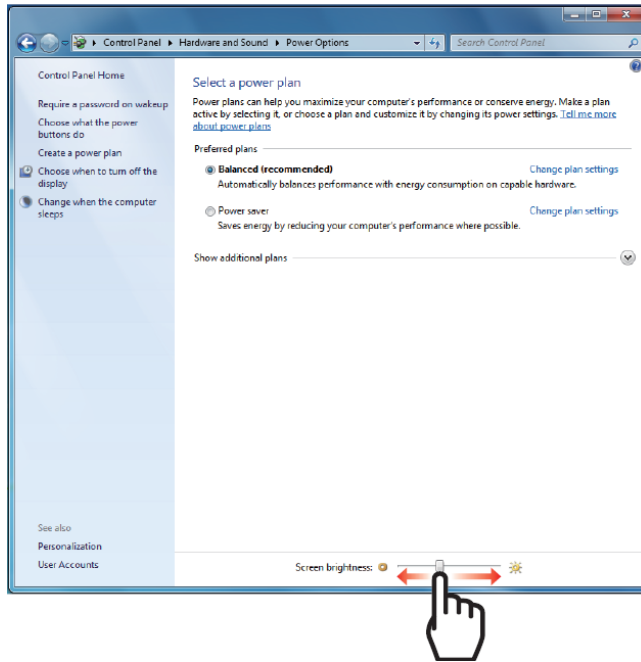

## **DRIVER INSTALLATION**

This chapter describes how to install all necessary drivers.



## CHAPTER 4: DRIVER INSTALLATION

This chapter provides guideline to driver installations.

### 4.1 Chipset Driver

**Step 1** Insert the CD that comes with the motherboard. Open the file document “Chipset Driver” and click “infinst\_auto.exe” to install driver.

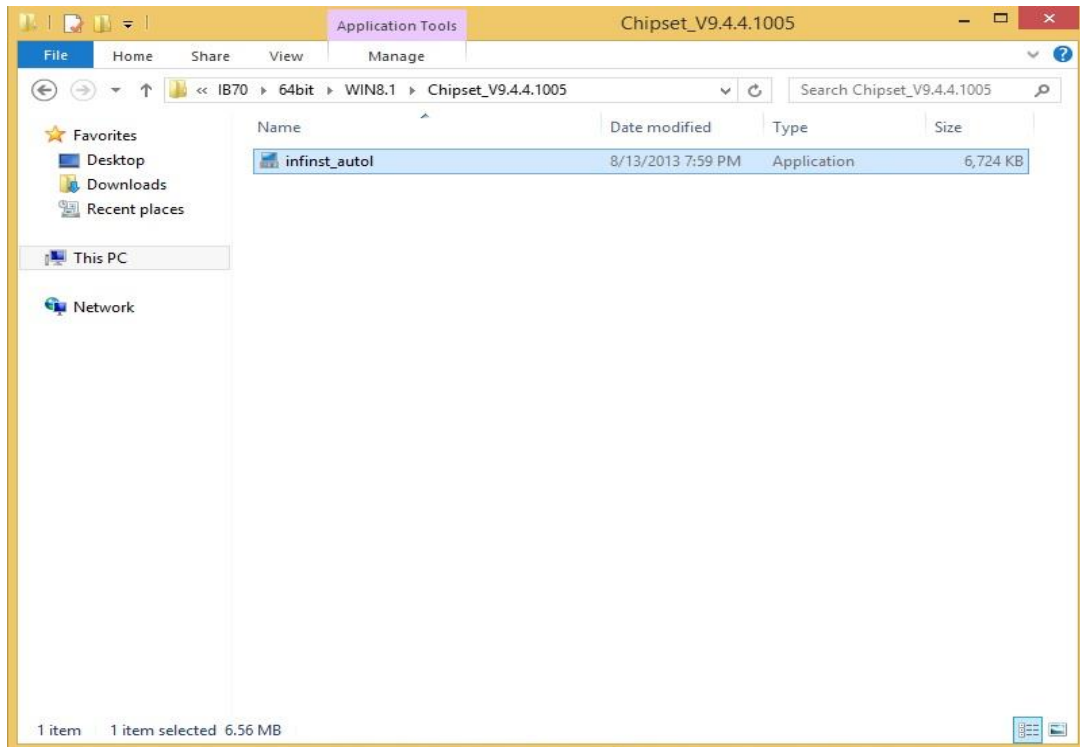

**Step 2** Click **Next** to continue.



**Step 3** Click **Yes** to agree the license terms.



**Step 4** Click **Next** to install the driver.



**Step 5** Software setup progress window will appear, click **Next** to continue.

**Step 6** Click **“Yes, I want to restart this computer now”** to finish the installation.

## 4.2 Graphics Driver

**Step 1** Insert the CD that comes with the motherboard. Open the file document “**Graphics Driver**” and click **Setup** to execute the setup.

**Step 2** Setup Welcome Window will appear, click **Next** to continue the process.

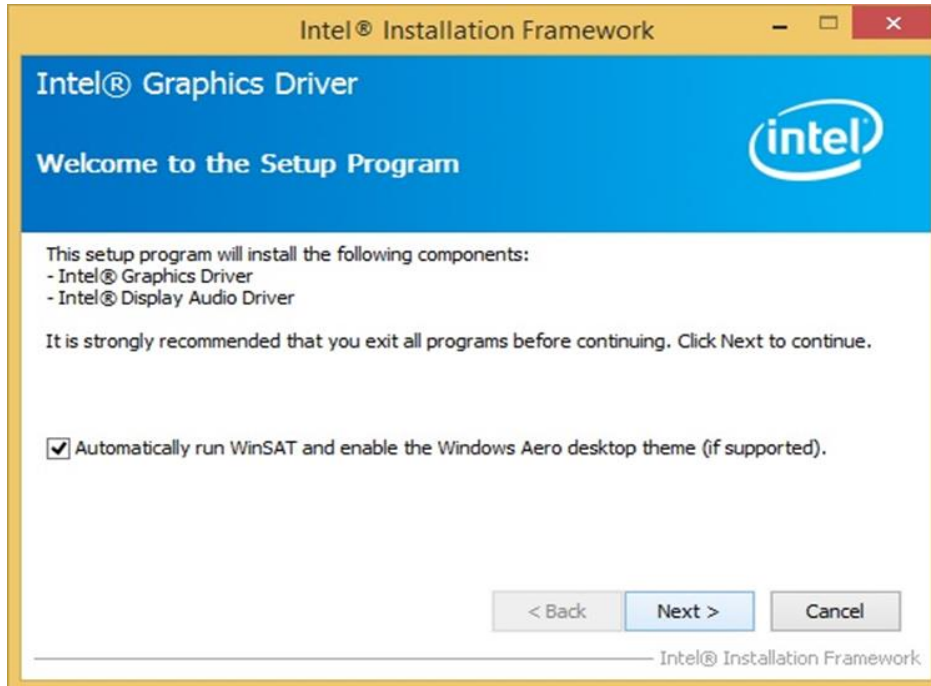

**Step 3** Carefully read the license terms and click **Yes** to agree.

**Step 4** Check Readme file information, and click **Next** to install driver.

**Step 5** Click **Next** to continue.

**Step 6** Windows Security window will appear, click “**Install this driver software anyway**” to continue.

**Step 7** Setup Progress window will appear, click **Next** to continue the installation.

**Step 8** Setup is complete, click “**Yes, I want to restart this computer now**” to finish the installation and restart the computer.

### 4.3 Audio Driver

The ALC886 series are high-performance 7.1+2 channel high definition audio codecs that provide ten DAC channels for simultaneous support of 7.1 sound playback, plus 2 channels of independent stereo sound output (multiple streaming) through the front panel stereo outputs. The series integrates two stereo ADCs that can support a stereo microphone, and feature Acoustic Echo Cancellation (AEC), Beam Forming (BF), and Noise Suppression (NS) technology.

**Step 1** Insert the CD that comes with the device. Open the file document “Audio Driver” and click “Setup.exe” to install the driver.

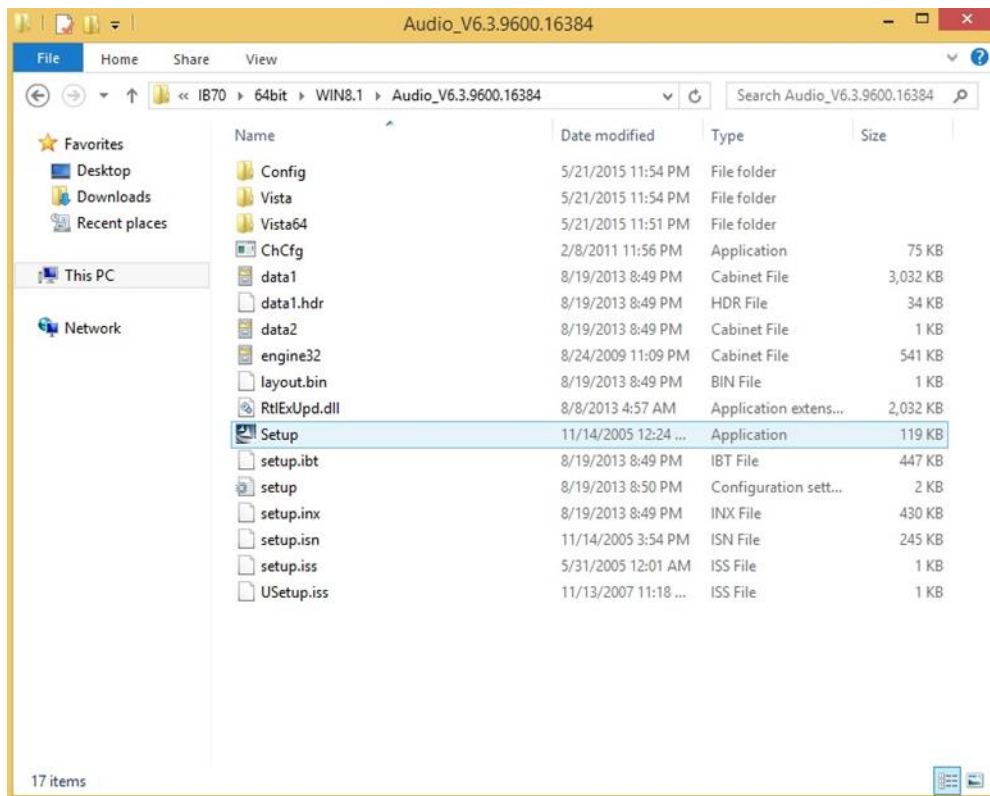

**Step 2** Please wait while the InstalShield Wizard prepares the setup.

**Step 3** Welcome window will appear, click **Next** to install the driver.

**Step 4** It might take some time to configure new software installation. Please wait.

**Step 5** Windows security will appear, click **Install** to install the audio driver.

**Step 6** The installation is complete, select “**Yes, I want to restart my computer now**”, and click **Finish** to complete the installation.



## 4.4 Intel Sideband Fabric Device (Intel MBI) Driver (Windows 8)

**Step 1** Insert the CD that comes with the motherboard. Open the file document “**MBI**” and click “**Setup.exe**” to install the driver.

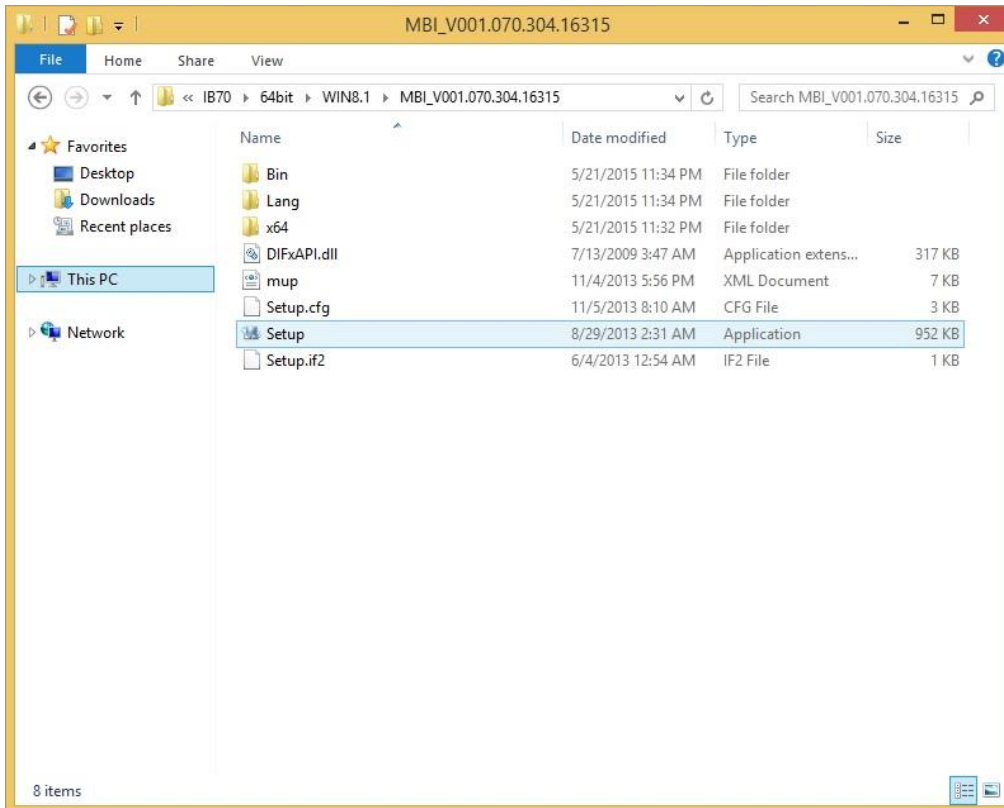

**Step 2** Welcome to the setup program window will appear, click **Next** to start the installation.

**Step 3** Carefully read the License Agreement terms and click **Yes** to agree.

**Step 4** Setup progress will appear, please wait for the operations to be performed, then click **Next** to continue.

**Step 5** The installation is complete, click “**Yes, I want to restart this computer now**” to finish and restart the computer.

## 4.5 Intel Trusted Engine Interface (Intel TXE) Driver

**Step 1** Insert the CD that comes with the motherboard. Open the file document “TXE” and click “Setup TXE.exe” to install the driver.

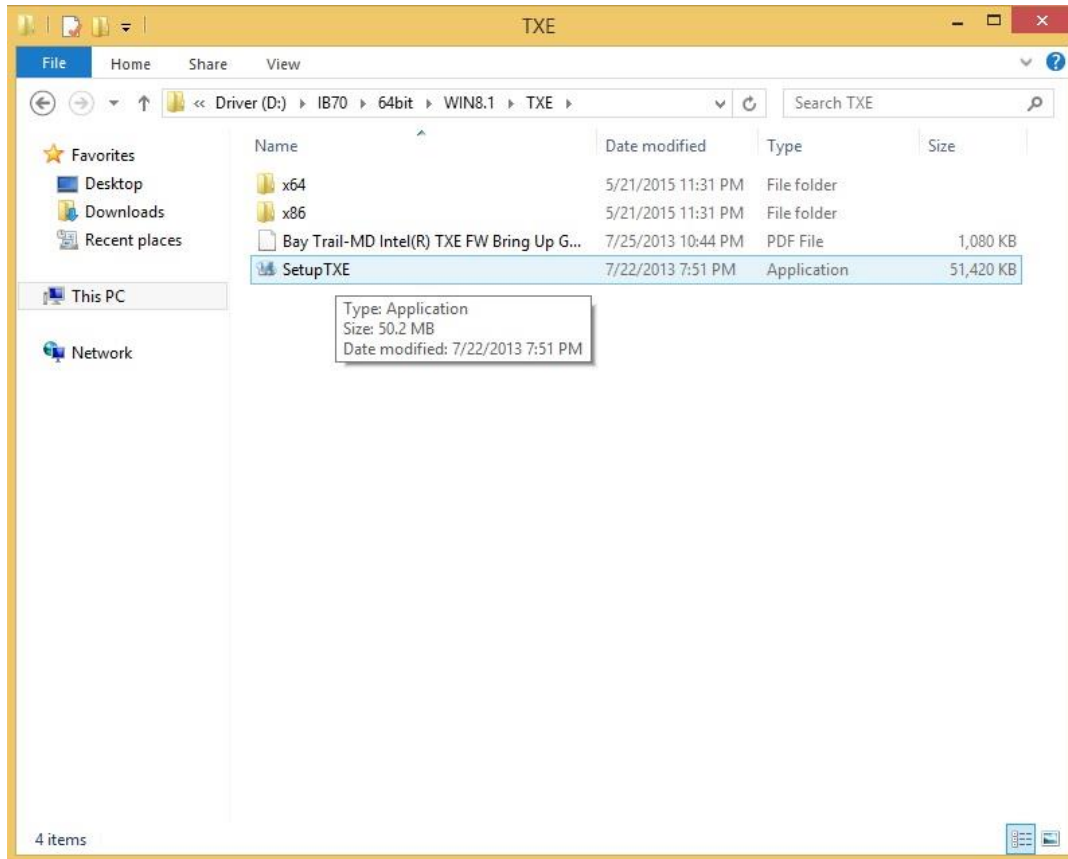

**Step 2** Welcome to the setup program window will appear, click **Next** to start the installation.

**Step 3** Carefully read the license terms and click **Yes** to agree.

**Step 4** Confirmation window will appear, click **Next** to continue the driver installation.

**Step 5** Please wait while the product is being installed.

**Step 6** The installation is complete, click **Finish** to complete the installation and restart the computer.

## 4.6 Intel Network Connections

User must confirm the type of operating system is being used before installing Intel Network Connections. Follow the steps below to complete the installation.

**Step 1** Click “PROWin64.exe”

**Step 2** Click **Yes** to start the installation.

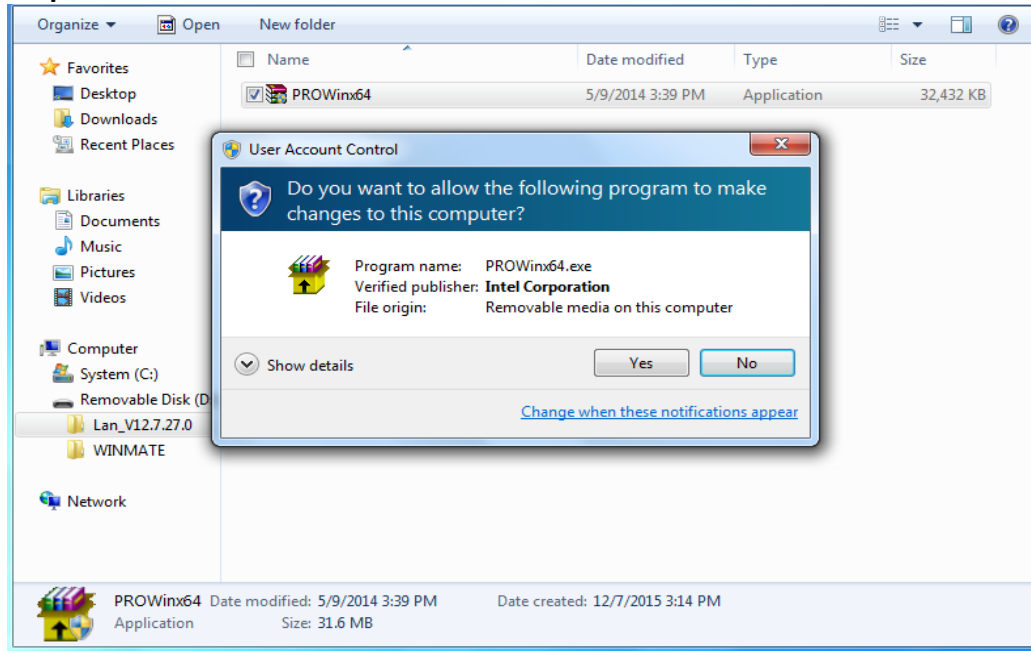

**Step 3** Welcome window will appear, click **Next** to install the driver.

**Step 4** In the program maintenance window you will see two options available. “Remove” is to remove Intel Networks Connections from your computer, and “Modify” is to make any changes. Choose **Modify** to continue.

**Step 5** In the **Setup Options** window choose “**Intel® PRO Set for Windows® Device Manger**”, “**Intel® Network Connections SNMP Agent**” and “**Advanced Network Services**”.

**Step 6** The wizard is ready to begin installation, click **Install** to continue.

**Step 7** Install wizard completed, click **Finish** to complete the installation.

## 4.7 USB 3.0 Driver (Windows 7)

**NOTE:**

If your operation system is Windows Embedded 8.1 Industry or Windows Embedded 8 Standard, you should skip the USB 3.0 driver installation.

You need to install the Intel® USB 3.0 extensible Host Controller driver to enable the function.

**Step 1** Locate the hard drive directory where the driver files are stored with the browser or the explore feature of Windows\*.

**Step 2** Double-click the “Setup.exe” from this directory.

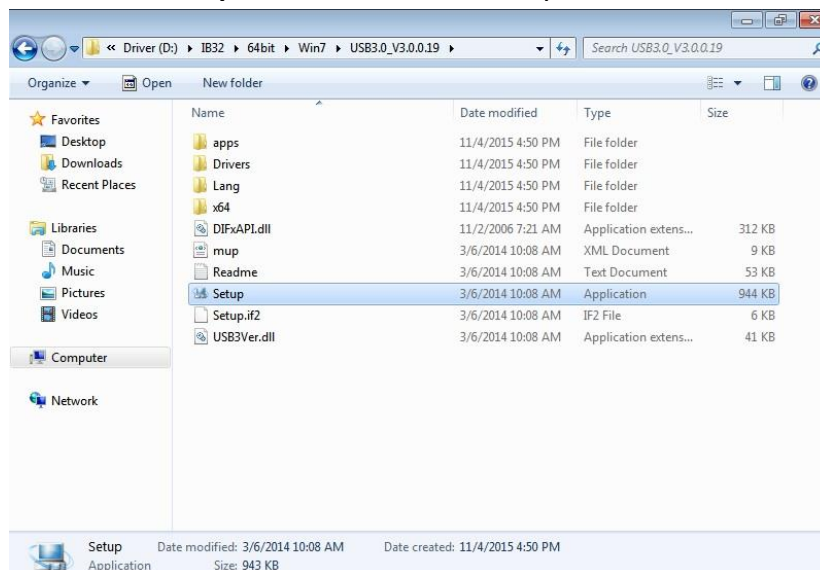

**Step 3** Welcome window will appear, Click **Next** to install the driver.

**Step 4** Carefully read the license terms and click **Yes** to agree.

**Step 5** Review Readme file information and click **Next** to continue the installation.

**Step 6** When the Setup Progress is complete click **Next** to continue.

**Step 7** Click “**Yes, I want to restart this computer now**” to finish and then restart your computer.

## **AMI UEFI BIOS Setup**

BIOS Setup Utility is a program for configuration basic Input / Output system settings of the HMI for optimum use. This chapter provides information on how to use BIOS setup, its functions and menu.

# 5

## CHAPTER 5: AMI UEFI BIOS SETUP

This chapter provides information on how to use AMI UEFI BIOS setup, its functions and menu.

### 5.1 When and How to Use BIOS Setup

To enter the BIOS setup, you need to connect an external USB keyboard, press **<Del>** key when the prompt appears on the screen during start up. The prompt screen shows only few seconds, you need to press **<Del>** key quickly. If the message disappears before your respond, restart the system by turning it OFF and ON, and enter the BIOS again.



**IMPORTANT:**

Updated BIOS version may be published after the manual released.  
Check the latest version of BIOS on the website.

Run BIOS setup utility for:

1. Error message on screen indicates to check BIOS setup
2. Restoring the factory default settings.
3. Modifying the specific hardware specifications
4. Necessity to optimize specifications

### 5.2 BIOS Functions

#### BIOS Navigation Keys

BIOS navigation keys for keyboard control are listed below.

The following keys are enabled during Power-On Self-Test (POST):

Key	Function
Del	Enters the BIOS setup menu.
F7	Display the boot menu. Lists all bootable devices that are connected to the system. With cursor $\uparrow$ and cursor $\downarrow$ and by pressing <b>&lt;ENTER&gt;</b> , select the device used for the boot.
Pause	Pressing the [Pause] key stops the POST. Press any other key to resume the POST.

The following Keys can be used after entering the BIOS Setup.

Key	Function
F1	General Help
F2	Previous Values
F3	Optimized Defaults
F4	Save & Exit
Esc	Exit
+/-	Change Opt.
Enter	Select or execute command
Cursor ↑	Moves to the previous item
Cursor ↓	Goes to the next item
Cursor ←	Moves to the previous item
Cursor →	Goes to the next item

**NOTE:**

You can press the F1, F2, F3, F4, +/-, and Esc keys by connecting a USB keyboard to your device.

### 5.2.1 Main Menu

When you enter BIOS setup, the first menu that appears on the screen is the main menu. It contains the system information including BIOS version, processor RC version, system language, time, and date. Immediately after the **[DEL]** key is pressed during startup, the main BIOS setup menu appears:

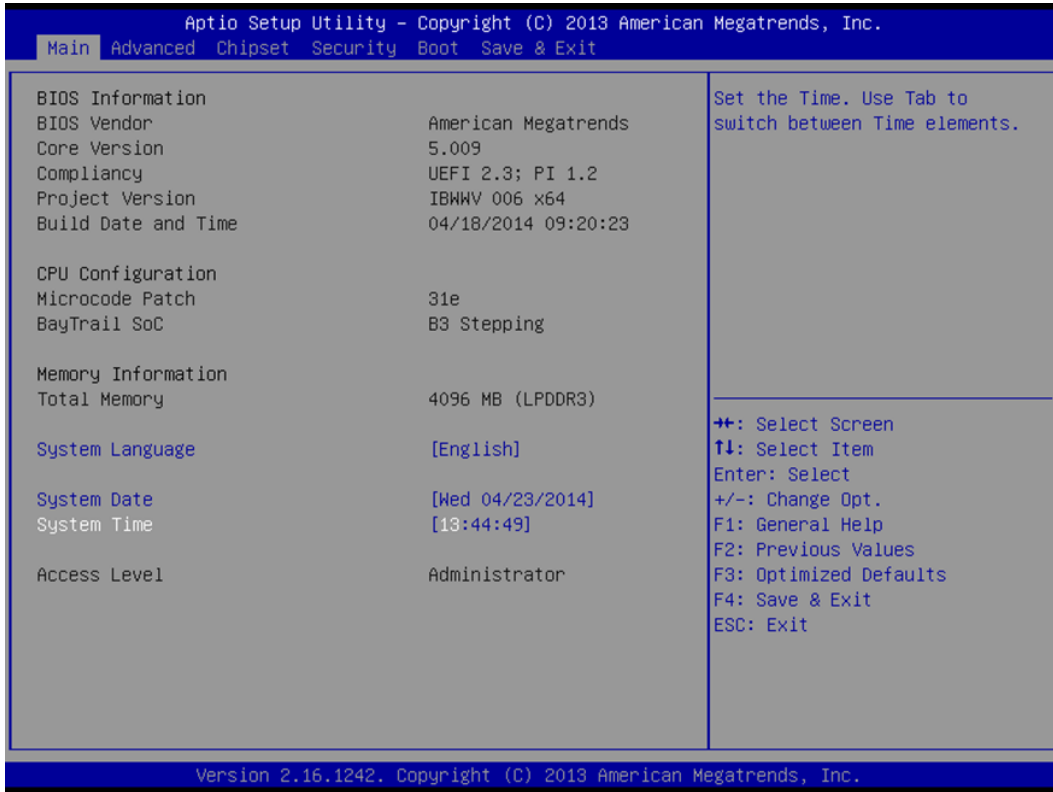

BIOS Setting	Description	Setting Option	Effect
System Language	Displays the system language. [English] is set up by default.	Adjustment of the language	Set the language in other language. The language in this device is English.
System Date/Time	This is current date setting. The time is maintained by the battery when the device is turned off.	Date and time changes.	Set the date in the format [mm/dd/yyyy]; The time in the format: [hh/mm/ss]
Access Level	The current user access settings	Changes to the level of access	Administrator is set up by the default



## 5.2.2 Advanced Menu

The advanced menu also uses to set configuration of the CPU and other system devices. There are sub menus on the left frame of the screen.



**IMPORTANT:**

Handle advanced BIOS settings page with caution. Any changes can affect the operation of your computer.

For items marked ► press <Enter> for more options.

Advanced Configuration and Power Interface (ACPI) settings allow to control how the power switch operates. The power supply can be adjusted for power requirements. You can use the screen to select options of ACPI configuration. A description of the selected items will appear on the right side of the screen.

BIOS Setting	Description
Intel AMT Support	Enable and disable BIOS support for Intel Active Management Technology.
Intel AMT Setup Prompt	Enable and disable the boot interruption <Ctrl+P> to call up Intel Management Engine BIOS Extension (MBEx) configuration page.
AMT CIRA Request Trig	Enable Client Initiated Remote Access (CIRA) Fast Call for Help. CIRA allows AMT maintenance event if the AMT PC is not in the intranet.
AMT CIRA Timeout	CIRA timeout for connection establishment with MPS (Manageability Presence Server / “vPro Enabled Gateway”).
Un-Configure ME	Resets all the values of the MEBx to their defaults (see section “Reset with Un-Configure”).
USB Configure	USB Configure: Enable and disable the USB configuration (provisioning).

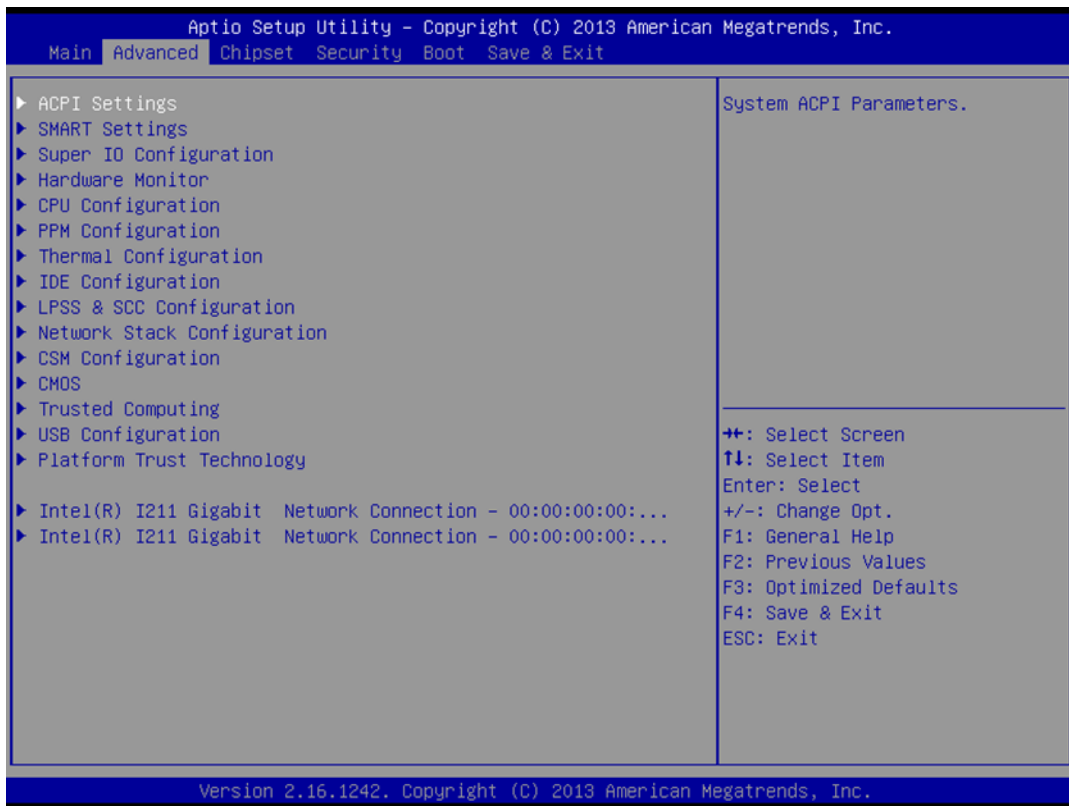

BIOS Setting	Description	Setting options	Effect
ACPI Settings	Configures ACPI settings	Enter	Opens submenu
SMART Settings	Configures SMART settings	Enter	Opens submenu
Super IO Configuration	Configures System Super IO Chip parameters	Enter	Opens submenu
Hardware Monitor	Monitor hardware status	Enter	Opens submenu
CPU Configuration	Configures CPU settings	Enter	Opens submenu
PPM Configuration	Configures PPM Parameters	Enter	Opens submenu
Thermal Configuration	Configures Thermal Parameters	Enter	Opens submenu
IDE Configuration	Configures IDE devices	Enter	Opens submenu
LPSS & SCC Configuration	Configures LPSS & SCC	Enter	Opens submenu
Network Stack Configuration	Configures network stack	Enter	Opens submenu
CSM Configuration	Configures CSM: Enable/Disable, Option ROM execution settings, etc.	Enter	Opens submenu
CMOS	CMOS settings / Information	Enter	Opens submenu
Trusting Computing	Trusted computing settings	Enter	Opens submenu
USB Configuration	Configures USB settings	Enter	Opens submenu
Platform Trust Technology	Platform trust technology	Enter	Opens submenu

For items marked ► press <Enter> for more options.

### 5.2.3 USB Configuration

Aptio Setup Utility - Copyright (C) 2013 American Megatrends, Inc.			
Advanced			
USB Configuration		Enables Legacy USB support. AUTO option disables legacy support if no USB devices are connected. DISABLE option will keep USB devices available only for EFI applications.	
USB Module Version	8.10.27		
USB Devices:	1 Drive, 1 Keyboard, 2 Hubs		
Legacy USB Support	[Enabled]		
USB3.0 Support	[Disabled]		
XHCI Hand-off	[Disabled]		
EHCI Hand-off	[Enabled]		
USB Mass Storage Driver Support	[Enabled]		
USB hardware delays and time-outs:			
USB transfer time-out	[20 sec]		
Device reset time-out	[20 sec]		
Device power-up delay	[Auto]		
Mass Storage Devices:		++: Select Screen ↑↓: Select Item Enter: Select +/-: Change Opt. F1: General Help F2: Previous Values F3: Optimized Defaults F4: Save & Exit ESC: Exit	
N/A	[Auto]		
Version 2.16.1242. Copyright (C) 2013 American Megatrends, Inc.			

BIOS Setting	Description	Setting options	Effect
Legacy USB Support	User can enable or disable USB port.	Disable	Will keep USB devices available only for EFI applications.
		Enable	Enable all the USB devices
USB 3.0 Support	User can enable or disable USB 3.0 (XHCI) controller support.	Enable	USB 3.0 is enable
		Disable	USB 3.0 is disable
XHCI Hand-off	This is a workaround for OSs without XHCI hand-off support.	Disable	Disables this function
		Enable	Enables this function
EHCI Hand-off	This is a workaround for OSs without ECHI hand-off support.	Disable	Disables this function
		Enable	Enables this function
USB mass storage driver support	User can Enable or disable USB mass storage driver support.	Disable	Disables this function
		Enable	Enables this function
USB Transfer time-out	The time-out value for control, bulk, and interrupt transfers.	1 Sec 5 Sec 10 Sec 20 Sec	Depends on the time-out value
Device Reset time-out	USB mass storage device start unit command time-out.	10 Sec 20 Sec 30 Sec 40 Sec	Depends on the time-out value
Device power-up delay	Maximum time the device will take before it properly reports itself to the host controller.	Auto	Uses default value: for a root port it is 100 ms, for a Hub port the delay is taken from Hub descriptor

## 5.2.4 Chipset

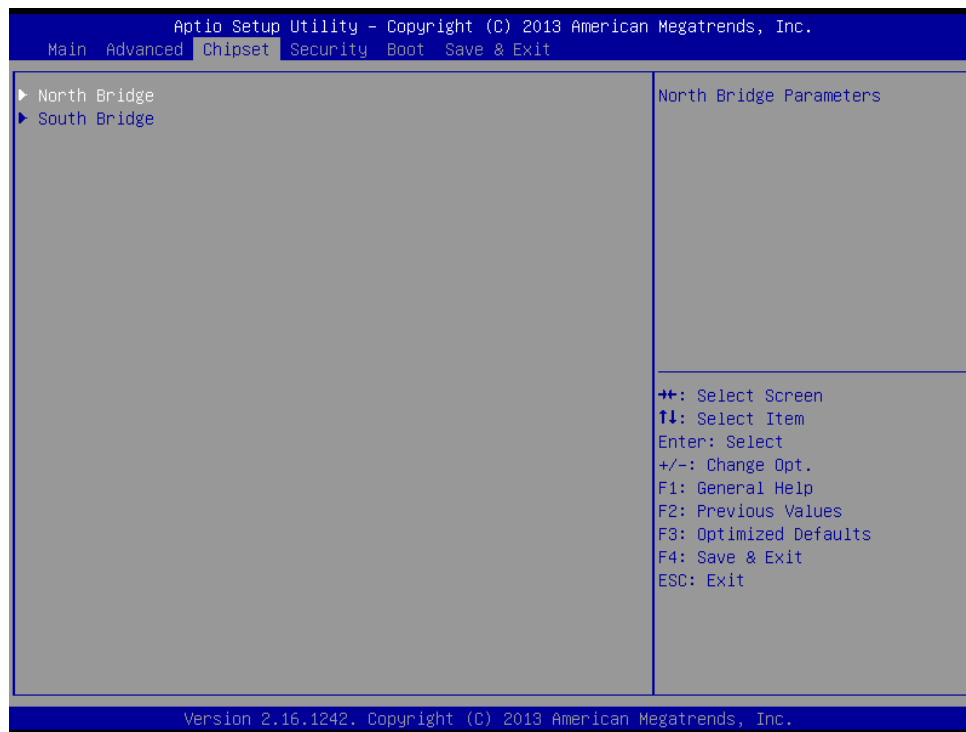

### 5.2.4.1 Chipset – North Bridge Parameters

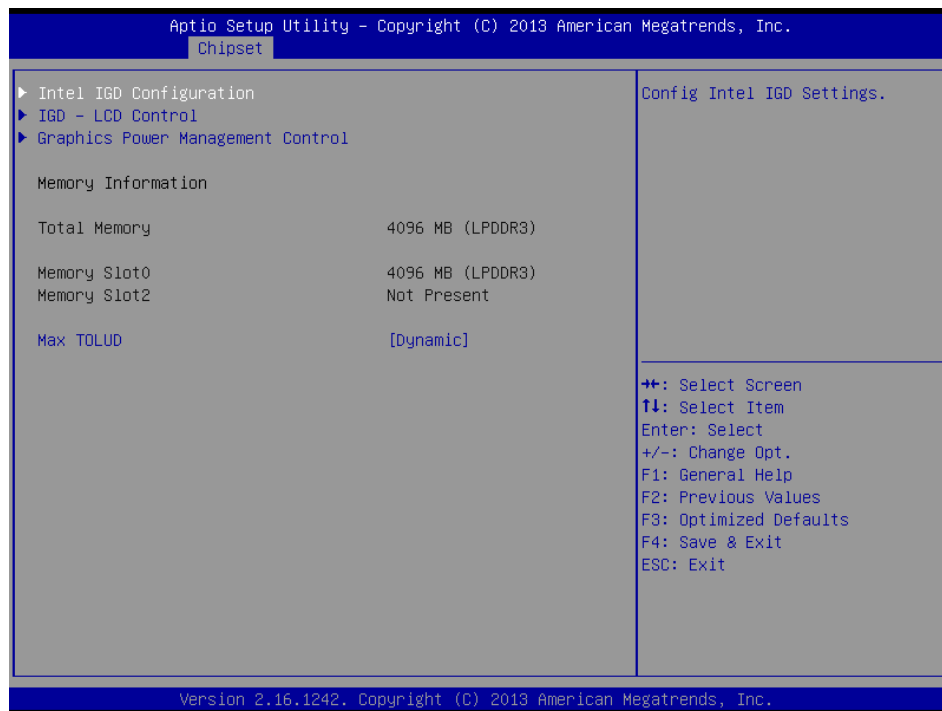

BIOS Setting	Description	Setting options	Effect
Intel IGD Configuration	Provides onboard graphics-related configuration options.	Enter	Opens submenu
IGD – LCD Control	Configures IGD – LCD setting	Enter	Opens submenu
Graphic Power Management Control	Provides power saving configuration options for the onboard graphics.	Enter	Opens submenu

### 5.2.4.2 Chipset – South Bridge Parameters

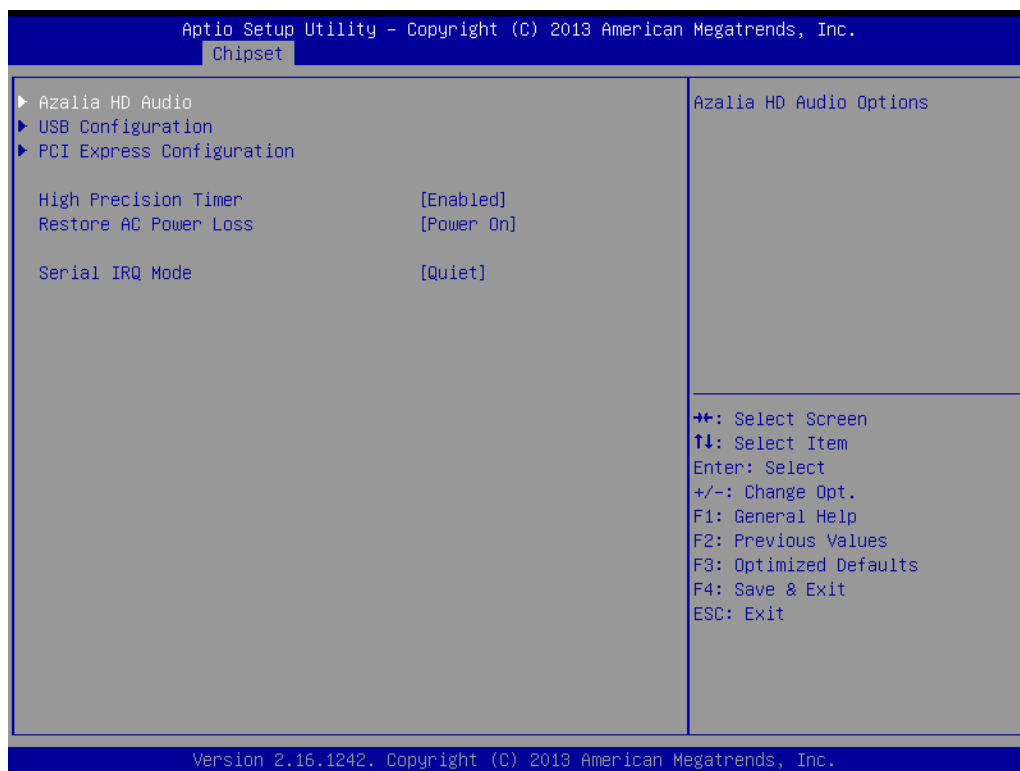

BIOS Setting	Description	Setting options	Effect
Azalia HD Audio	Configures onboard audio function.	Disable	Disables this function
		Enable	Enables this function
USB Configuration	Provides user with configuration options for the USB controller, such as enabling/disabling a specific USB port and support for certain features.	USB 2.0(EHCI)	Enable / Disable this function
		USB Port 0	Enable / Disable this function
		USB Port 1	Enable / Disable this function
		USB Port 2	Enable / Disable this function
		USB Port 3	Enable / Disable this function
PCI Express Configuration	Provides user with configuration options for the PCI Express bus, such as enabling/disabling a specific PCI Express channel and speed configuration.	PCI Express port 0	Enable / Disable this function
		PCI Express port 1	Enable / Disable this function
		PCI Express port 2	Enable / Disable this function
		PCI Express port 3	Enable / Disable this function
High Precision Timer	Configures high precision timer (HPET) in the operating system.	Disable	Disables this function
		Enable	Enables this function
Restore AC Power Loss	Configures the state of the system after return of power on AC power loss.	Power Off	The System stays off upon the return of the AC power
		Power On	The System is turned on upon the return of the AC power
		Last State	The system returns to its last known awake state upon the return of the AC power
Serial IRQ Mode	Configures IRQ mode.	Quite	Entering quite (active) mode
		Continuous	Entering Continuous (idle) mode



### 5.2.5 Security

Allows user to configure an administration or user password, user must enter the administrator or user password at system startup and when entering BIOS setup.

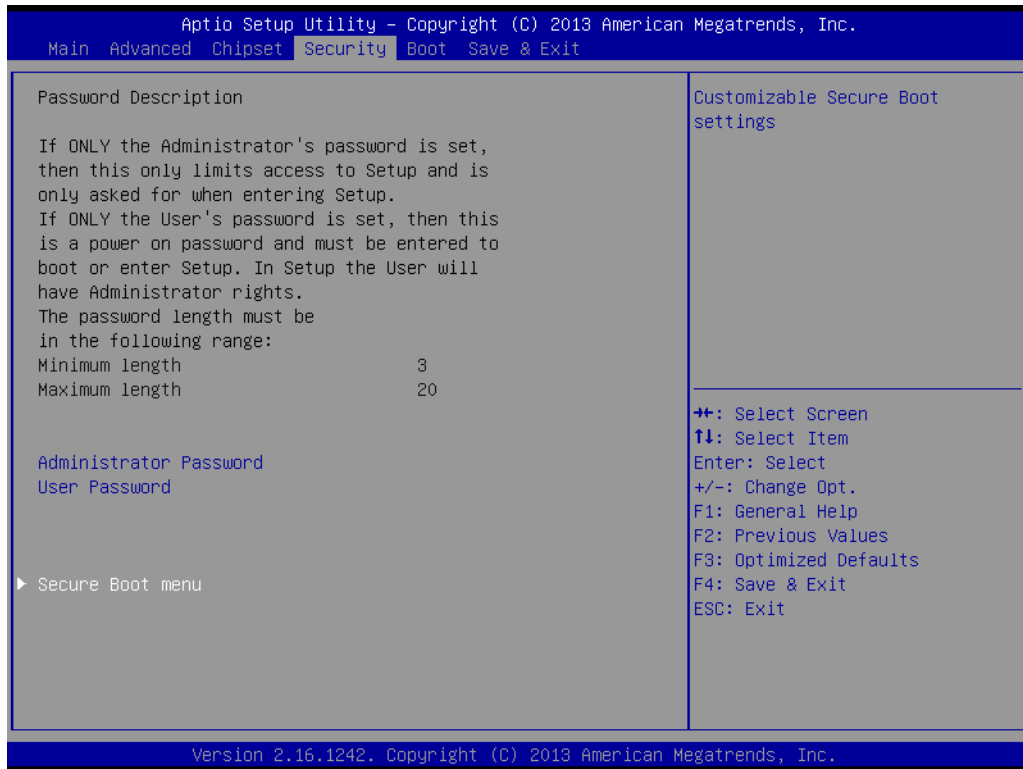

BIOS Setting	Description	Setting options	Effect
Administrator Password	Displays whether or not an administrator password has been set.	Enter	Enter Password
User Password	Display whether or not a user password has been set.	Enter	Enter Password

**5.2.5.1 Security – Secure Boot Menu**

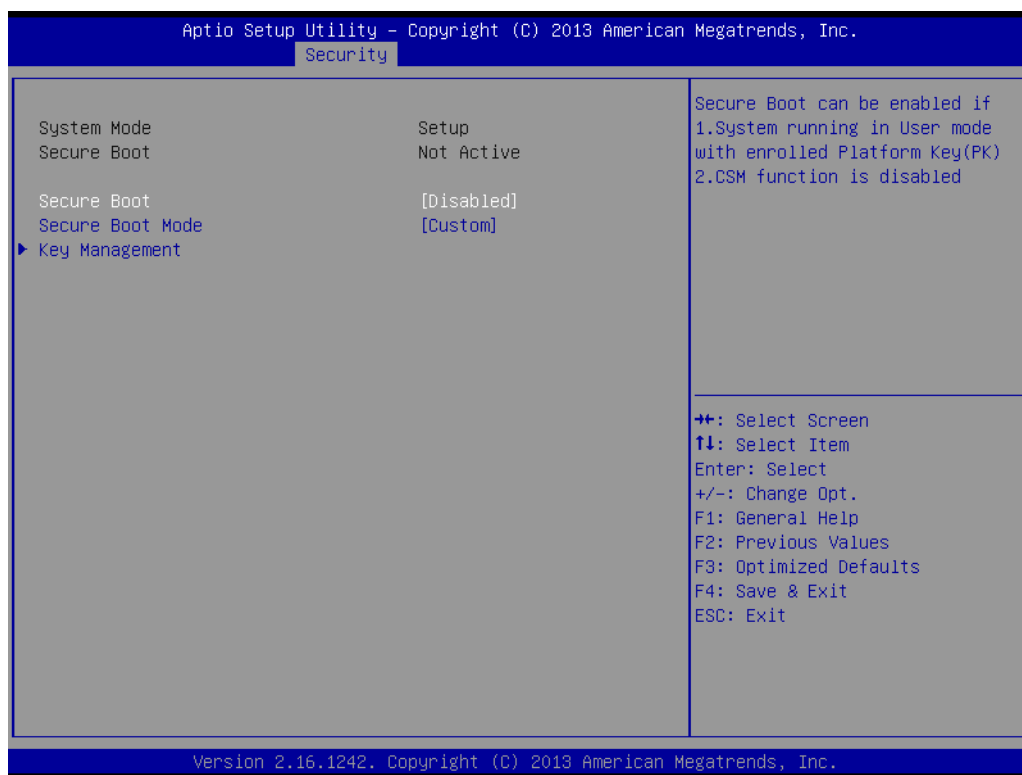

BIOS Setting	Description	Setting options	Effect
Secure Boot	Displays the current boot state.	Disable	Disables this function
		Enable	Enables this function
Secure Boot Mode	Allows user to configure the secure boot mode.	Disable	Disables this function
		Enable	Enables this function
Key Management	Provides user with configuration options for secure boot key management.	Enroll all factory default keys, Platform key, key exchange key, Authorized signatures, Authorized timestamps, Forbidden signatures	Select the desired key

## 5.2.6 Boot

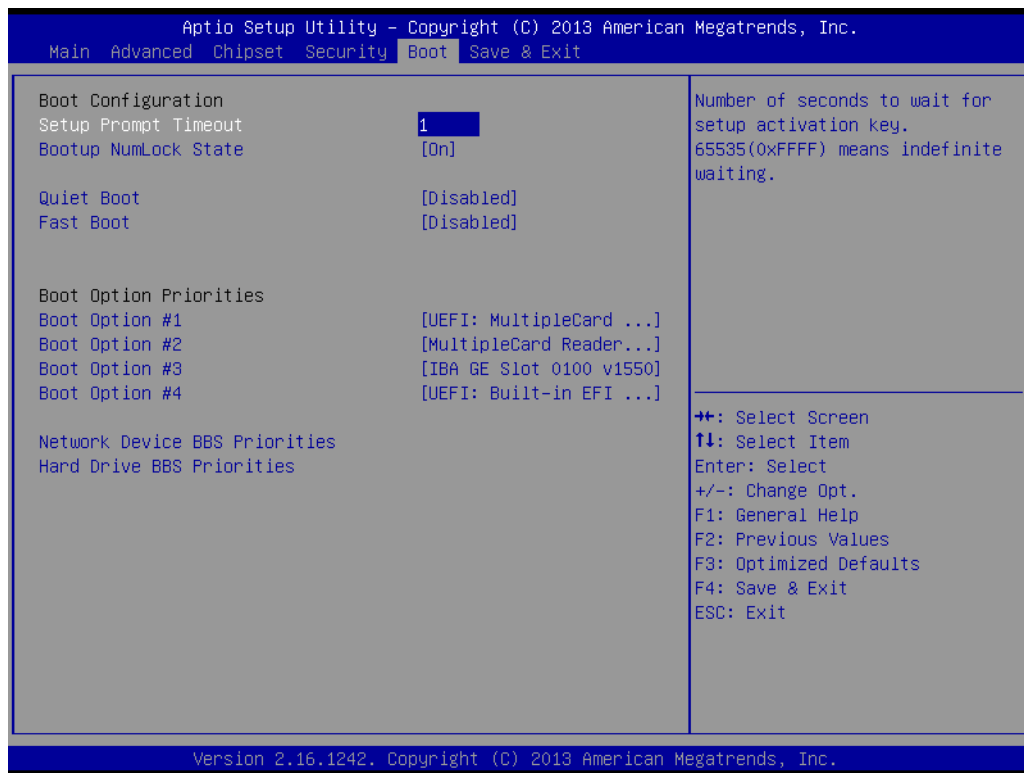

BIOS Setting	Description	Setting options	Effect
Setup Prompt Timeout	Allows user to configure the number of seconds to stay in BIOS setup prompt screen.	Enter	Set the prompt timeout
Boot NumLock State	Enables or disables NumLock feature on the numeric keypad of the keyboard after the POST (Default: On).	On	Remains On
		Off	Remains Off
Quiet Boot	Determines if POST message or OEM logo (default = Black background) is displayed.	Disabled	Disables this function
		Enabled	Enables this function
Fast Boot	Enables or disables Fast Boot to shorten the OS boot process. (Default: Disabled).	Disable	Disables this function
		Enable	Enables this function
Boot Option Priority	Specifies the overall boot order from the available devices.	Ex: Boot Option#1 (hard drive)	Hard drive as the first priority
Hard Drive BBS Priority	Specifies the boot order for a specific device type, such as hard drives, optical drives, floppy disk drives, and devices that support Boot from LAN function.	Enter	Enter the submenu that present the devices of the same type are connected.

## 5.2.7 Save & Exit

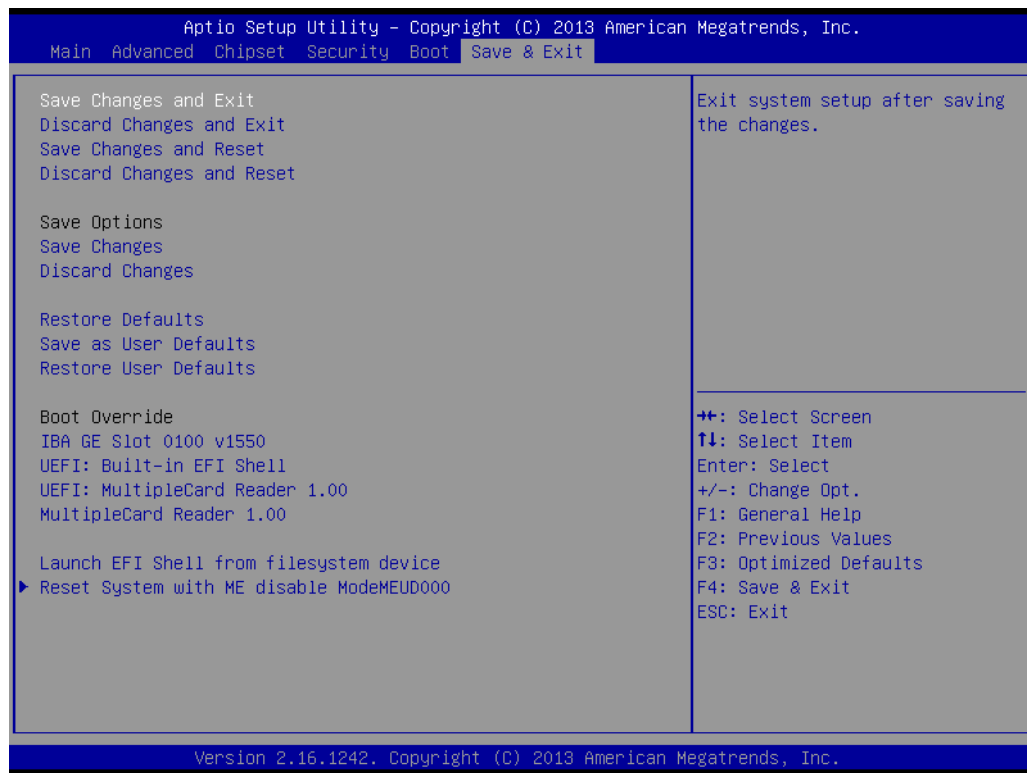

BIOS Setting	Description	Setting options	Effect
Save Changes and Exit	This saves the changes to the CMOS and exits the BIOS Setup program.	Enter <Yes>	Saves the changes
		Esc <No>	Return to the BIOS Setup Main Menu
Discard Changes and Exit	This exits the BIOS Setup without saving the changes made in BIOS Setup to the CMOS.	Enter <Yes>	Saves the changes
		Esc <No>	Return to the BIOS Setup Main Menu
Save Changes and Reset	Reset the system after saving the changes.	Enter <Yes>	Saves the changes
		Esc <No>	Return to the BIOS Setup Main Menu
Discard Changes and Reset	Reset system setup without saving any changes.	Enter <Yes>	Saves the changes
		Esc <No>	Return to the BIOS Setup Main Menu
Save Changes	Save changes done so far to any of the setup options.	Enter <Yes>	Saves the changes
		Esc <No>	Return to the BIOS Setup Main Menu
Discard Changes	Discard changes done so far to any of the setup options.	Enter <Yes>	Saves the changes
		Esc <No>	Return to the BIOS Setup Main Menu
Restore Default	Restore/load default values for all the setup options.	Enter <Yes>	Saves the changes
		Esc <No>	Return to the BIOS Setup Main Menu
Save as User Defaults	Save the changes done so far as User defaults.	Enter <Yes>	Saves the changes
		Esc <No>	Return to the BIOS Setup Main Menu
Restore User Defaults	Restore the User Defaults to all the setup options.	Enter <Yes>	Saves the changes
		Esc <No>	Return to the BIOS Setup Main Menu

## 5.3 Using Recovery Wizard to Restore Computer

**Note:**

Before starting the recovery process, make sure to backup all user data. The data will be lost after the recovery process.

To enable quick one-key recovery procedure:

- Plug-in the AC adapter to the computer. Make sure the computer stays plugged in to power source during the recovery process.
- Turn on the computer, and when the boot screen shows up, press the **F6** to initiate the Recovery Wizard.
- The following screen shows the Recovery Wizard. Click **Recovery** button to continue.



A warning message about data loss will show up. Make sure the data is backed up before recovery, and click **Yes** to continue.



Wait the recovery process to complete. During the recovery process, a command prompt will show up to indicate the percent of recovery process complete. The system will restart automatically after recovery completed.





## **MOUNTING**

This chapter provides step-by-step mounting guide for all available mounting options.

# 6

## CHAPTER 6: MOUNTING

This chapter provides mounting guide for all available mounting options. Pay attention to cautions and warning to avoid any damages.

**WARNING! / AVERTISSEMENT!**

Follow mounting instructions and use recommended mounting hardware to avoid the risk of injury.

Suivez les instructions de montage et d'utilisation recommandé le matériel de montage pour éviter le risque de blessure.

### 6.1 Cable Mounting Considerations

For a nice look and safe installation, make sure cables are neatly hidden behind the HMI device. Refer to [Chapter 2, section 2.1](#) for the cable installation instruction.

**WARNING! / AVERTISSEMENT!**

Observe all local installation requirements for connection cable type and protection level.

Suivre tous les règlements locaux d'installations, de câblage et niveaux de protection.

**WARNING! / AVERTISSEMENT!**

Turn off the device and disconnect other peripherals before installation. Éteindre l'appareil et débrancher tous les périphériques avant l'installation.

**ALTERNATING CURRENT / MISE À LE TERRE!**

To prevent electrical shock, the Safety Ground location on the rear must be bonded to the local earth ground through a minimum 12 AWG wire as short as possible

Pour éviter les chocs électriques, l'emplacement de la prise terre à l'arrière doit être lié à terre locale, à travers un 12 AWG minimum et aussi court que possible.

## 6.2 Safety Precautions

Observe the following common safety precautions before installing any electronic device:

- Use separate, non-intersecting paths to route power and networking wires. If power wiring and device wiring paths must be crossed make sure the wires are perpendicular at the intersection point.
- Keep the wires separated according to the interface. Wires that share similar electrical characteristics must be bundled together.
- Do not bundle input wiring with output wiring. Keep them separate.

When necessary, it is strongly advised that you label wiring to all devices in the system.

## 6.3 Mounting Guide

M-series HMI devices come with different mounting options suitable for most of the industrial and commercial applications.

### 6.3.2 Panel Mounting

Panel Mounting solution allows installing the HMI device onto the wall.

Cutout dimension ( W x D in mm)				
12.1"	15"	17"	19"	21.5"
301 x 237	342 x 261	373 x 311	412 x 338	504 x 304
Mounting Clips				
8 pcs	12 pcs	12 pcs	14 pcs	16 pcs
Screws				
Short screws: 15mm M4				
Long screws: 30mm M4				

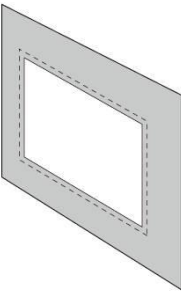
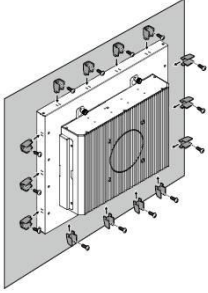
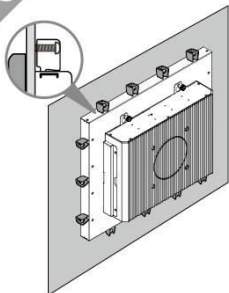
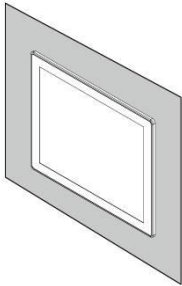
<p><b>1</b></p> 	<p>Prepare a cutout on a fixture according to the cutout dimensions.</p>	<p><b>2</b></p> 	<p>Select the mounting holes according to the wall thickness of the fixture and secure the mounting clips onto four sides of the HMI device.</p>
<p><b>3</b></p> 	<p>Secure the HMI to the fixture by screws.</p>	<p><b>4</b></p> 	<p>Connect power and other peripherals to the HMI unit.</p>



**NOTE:** Use either short (15mm) or long (30mm) screws based on the thickness of the wall.

### **6.3.1 VESA Mounting**

M-Series HMI comes with VESA mount holes on the rear side. Follow instructions below to mount the unit with VESA Mount bracket (not supplied by Winmate).

<b>VESA Plate Dimensions</b>	<b>Screw Hole Diameter</b>	<b>Compatibility</b>
100 x 100 mm	VESA M4 x 5 mm	Swingarms mounting kits

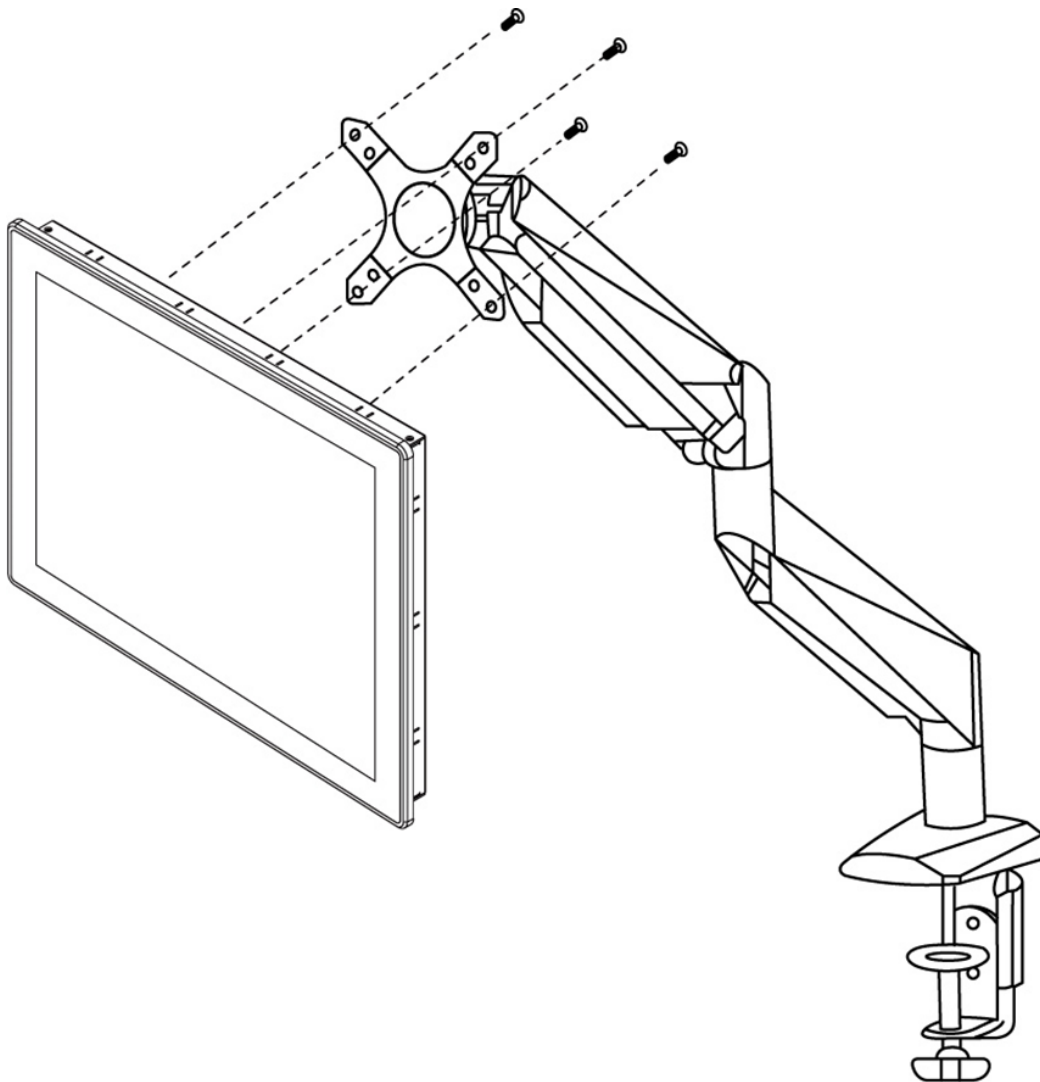

#### **Mounting Steps:**

1. Screw VESA Bracket to the fixture (ex. wall) with M4 VESA screws.
2. Place the device on VESA bracket (not supplied by Winmate).

## **TECHNICAL SUPPORT**

This chapter includes directory to technical support



## CHAPTER 7: TECHNICAL SUPPORT

This chapter includes technical support documents and software developing kit (SDK). If any problem occurs fill in [problem report form](#) enclosed and immediately contact us.

### 7.1 Software Developer Support

Winmate provides the following development kits (SDK) for M-Series HMI with Intel® Atom™ E3845 processor:

Item	File Type	Description
1	Watchdog SDK & AP	Watchdog SDK and AP

You can download SDK and Drivers from Winmate Download Center or Winmate File Share.

#### 7.1.1 Winmate Download Center

<http://www.winmate.com.tw/>>Support > Download Center > Multi-Touch PPC > M-Series HMI Atom E3845 > Drivers/ Development Kit

Or follow the link below:

<http://www.winmate.com/DownCenter/DownLoadCenter.asp?DownType=3009>

#### 7.1.2 Winmate File Share

<http://www.winmate.com/>> Support > Download Center >Public Documents > Panel PC > Multi-Touch HMI > M-Series HMI > 15~21.5" Atom E3845 >Drivers / Development Kit

Or follow the link below: <https://winmate.box.com/v/M-Series-HMI-Intel-Atom>





## **PRODUCT SPECIFICATIONS**

This section includes product specifications.



## APPENDIX A: PRODUCT SPECIFICATIONS

	Model Name				
	R12IBWS-MHM2	R15IBWS-MHC3	R17IBWS-MHM1	R19IBWS-MHA1	W22IBWS-MHA3
<b>Display</b>					
Size	12"	15"	17"	19"	21.5"
Active Display Area (H x V)	245.76 x 184.32	304.1 x 228.1	337.9 x 270.3	376.32 x 301.06	476.64 x 268.11
Pixel Pitch (H x V)	0.240 x 0.240	0.297x 0.297	0.264 x 0.264	0.294 x 0.294	0.248 x 0.248
Display Colors	262k / 16.2M				
Resolution	1024 x 768	1024 x 768	1280 x 1024	1280 x 1024	1920 x 1080
Brightness	500 nits	250 nits	350 nits	350 nits	250 nits
Contrast Ratio	700:1 (Typ.)	700:1 (typ.)	1000:1 (typ.)	1000:1 (typ.)	3000:1 (typ.)
Viewing Angle	80/80/70/70	80/80/70/70	85/85/80/80	85/85/80/80	89/89/89/89
Touch	P-Cap	P-Cap, optional AG Coating	P-Cap	P-Cap, optional AG Coating	P-Cap, optional AG Coating
<b>System</b>					
Processor	Intel® Atom™ E3845, 2M cache up to 1.91 GHz				
System Memory	SODIMM DDR3L-1600 4 GB, optional up to 8GB (2 slots)				
System Chipset	Intel® HD graphics 4400				
Main Storage	Default 2.5" 64GB SSD, optional up to 128GB				
Second Storage (Optional)	Internal mSATA 64 - 256GB SSD				
Ethernet	1000 Base-Tx Gigabit Ethernet				
Audio	Realtek ALC886 codec				
<b>Operating System</b>					
Optional OS	Windows 10 IoT Enterprise Windows Embedded 8 Standard Windows Embedded Standard 7				
<b>Input/ Output</b>					
Input	1 x 12-24V isolated DC in (3-pin terminal block) 2 x Gigabit LAN 4 x USB 2.0 1 x COM1 (RS-232/422/485 programmable port) 1 x Audio IN jack				
Output	1 x HDMI 1 x VGA (D-Dub 15) 1 x Audio OUT jack				

User Interfaces	1 x Reset Key 1 x Power Button 1 x 2.5" SSD Slot				
<b>Mechanical Specification</b>					
Cooling System	Fanless design				
Mounting	Wall mount, VESA mount				
Dimensions (L x W x H)	322 x 256 x 91	367 x 291 x 80	398.16 x 330.54 x 79.6	445.72 x 370.46 x 79.6	532.6 x 324.1 x 79.2
<b>Environmental Consideration</b>					
Operating Temperature	0 to +50°C				
Operating Humidity	30%~95% at 40°C (non-condensing, RH)				
IP Rating	Front: IP65 Full: IP20				
<b>Power Specifications</b>					
Power Input	12-24V DC				
Power Adapter	110-240 AC to 12V DC out 80W				



**Winmate Inc.**

9F, No.111-6, Shing-De Rd., San-Chung District,  
New Taipei City 24158, Taiwan, R.O.C

Tel: 886-2-8511-0288

Fax: 886-2-8511-0211

Email: [sales@winmate.com.tw](mailto:sales@winmate.com.tw)

Official website: [www.winmate.com](http://www.winmate.com)